

Description

Metric, AT shape, Modified trapezoidal, 10 mm pitch, Highly flexible steel cord

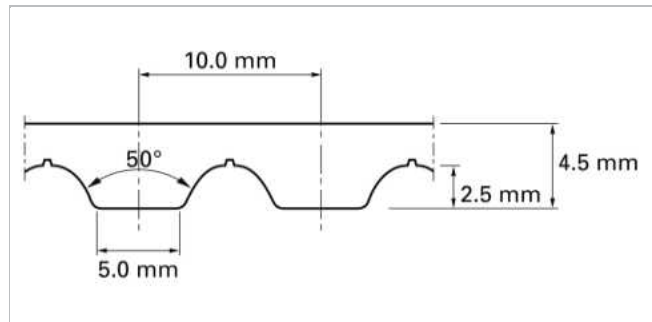
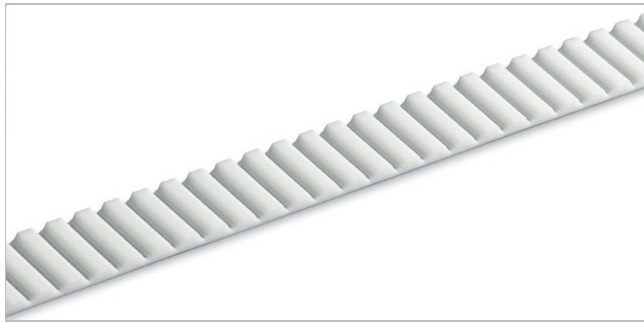

Sketch of basic shape

Product Construction / Design								
Material Type	Color	Hardness	Temperature range				Food grade ¹	Characteristic
			°C	°F	°C	°F		
12	Transparent	92	-40	-40	80	176	Yes	TPO
01	White	92	-20	-4	80	176	No	TPU - polyester
05	Cobalt blue	90	-30	-22	80	176	Yes	TPU - polyether
16	Transparent	85	-30	-22	80	176	Yes	TPU - polyester
22	Transparent	90	-20	-4	70	158	Yes	TPU - polyester
06	Black	92	-20	-4	80	176	No	TPU - polyester

⁽¹⁾ This product is in compliance with relevant EU and/or US food contact requirements. Check the following link for detailed information [Documents of Compliance](#)

Standard belt options - Conveying side

Unprocessed (U)

Standard belt options - Teeth side

Unprocessed (U), Green polyamide fabric (P), Antistatic black polyamide fabric (A)⁽²⁾

⁽²⁾ Fulfills ISO 9563

Technical data									
Belt slitting width, nominal		Admissible tensile force, truly endless belt		Ultimate tensile strength		Tensile force for 1% elongation		Mass of belt (belt weight)	
mm	inch	N	lbf	N	lbf	N	lbf	kg/m	lb/ft
50.0	2.0	6160	1385	31220	7019	18570	4175	0.34	0.23

Maximum belt width (150 mm / 6 inch).

Belt versions with increased thickness are available on request. Please consider larger minimum pulley diameters.

The admissible tensile force always corresponds with a belt elongation of 0.4%. Joined belts are calculated with half admissible force. Please contact Habasit for detailed information and calculations.

[Link to JDS:](#)

Unit load table

RPM	F _i	M _i	P _i	RPM	F _i	M _i	P _i	RPM	F _i	M _i	P _i
[min ⁻¹]	[N/cm]	[Nm/cm]	[W/cm]	[min ⁻¹]	[N/cm]	[Nm/cm]	[W/cm]	[min ⁻¹]	[N/cm]	[Nm/cm]	[W/cm]
0	75.64	0.1204	0.000	1200	48.50	0.0772	9.691	3600	32.59	0.0518	19.524
20	74.47	0.1186	0.248	1300	47.47	0.0756	10.279	3800	31.79	0.0505	20.087
40	73.36	0.1170	0.490	1400	46.43	0.0739	10.825	4000	30.95	0.0492	20.616
60	72.55	0.1153	0.724	1500	45.47	0.0722	11.342	4500	29.10	0.0463	21.829
80	71.62	0.1139	0.954	1600	44.56	0.0710	11.890	5000	27.44	0.0437	22.884
100	70.54	0.1126	1.178	1700	43.72	0.0696	12.379	5500	25.98	0.0414	23.810
200	66.92	0.1066	2.232	1800	42.89	0.0682	12.849	6000	24.64	0.0392	24.616
300	64.00	0.1018	3.197	1900	42.05	0.0670	12.323	6500	23.39	0.0371	25.233
400	61.26	0.0976	4.087	2000	41.35	0.0659	13.792	7000	22.13	0.0353	25.845
500	59.06	0.0939	4.915	2200	39.97	0.0635	14.629	7500	21.10	0.0335	26.278
600	57.11	0.0909	5.705	2400	38.73	0.0616	15.465	8000	20.05	0.0320	26.765
700	55.22	0.0880	6.445	2600	37.49	0.0598	16.260	8500	19.09	0.0304	27.056
800	53.65	0.0854	7.148	2800	36.33	0.0580	16.993	9000	18.15	0.0289	27.243
900	52.21	0.0830	7.819	3000	35.32	0.0563	17.682	9500	17.30	0.0275	27.317
1000	50.88	0.0810	8.477	3200	34.36	0.0548	18.337	10000	16.47	0.0263	27.492
1100	49.64	0.0791	9.105	3400	33.43	0.0532	18.925				

Technical data					
ØB		n _B	ØA		n _A
mm	inch		mm	inch	
50	1.97	15	80	3.15	20



All data are approximate values under **standard climatic conditions**: 23 °C / 73 °F, 50% relative humidity (DIN 50005 / ISO 554), and are based on the Master Joining Method.

Limited representative testing based on a standard configuration is carried out to estimate minimum pulley diameters. Please contact Habasit for specific guidance regarding non-standard applications, including, but not exclusively, when profiles or cleats are used, or if the belt working temperature is close to the limits listed in this document.

Disclaimer

Product Application Disclaimer (valid for ALL Habasit products and mentioned on all PDS)

This disclaimer is made by and on behalf of Habasit and its affiliated companies, directors, employees, agents and contractors (hereinafter collectively "HABASIT") with respect to the products referred to herein (the "Products"). SAFETY WARNINGS SHOULD BE READ CAREFULLY AND ANY RECOMMENDED SAFETY PRECAUTIONS BE FOLLOWED STRICTLY! Please refer to the Safety Warnings herein, in the Habasit catalogue as well as installation and operating manuals. All indications / information as to the application, use and performance of the Products are recommendations provided with due diligence and care, but no representations or warranties of any kind are made as to their completeness, accuracy or suitability for a particular purpose. The data provided herein are based on laboratory application with small-scale test equipment, running at standard conditions, and do not necessarily match product performance in industrial use. New knowledge and experience may lead to re-assessments and modifications within a short period of time and without prior notice. EXCEPT AS EXPLICITLY WARRANTED BY HABASIT, WHICH WARRANTIES ARE EXCLUSIVE AND IN LIEU OF ALL OTHER WARRANTIES, EXPRESS OR IMPLIED, THE PRODUCTS ARE PROVIDED "AS IS". HABASIT DISCLAIMS ALL OTHER WARRANTIES, EITHER EXPRESS OR IMPLIED, INCLUDING, BUT NOT LIMITED TO, IMPLIED WARRANTIES OF MERCHANTABILITY, FITNESS FOR A PARTICULAR PURPOSE, NON-INFRINGEMENT, OR ARISING FROM A COURSE OF DEALING, USAGE, OR TRADE PRACTICE, ALL OF WHICH ARE HEREBY EXCLUDED TO THE EXTENT ALLOWED BY APPLICABLE LAW. BECAUSE CONDITIONS OF USE IN INDUSTRIAL APPLICATION ARE OUTSIDE OF HABASIT'S CONTROL, HABASIT DOES NOT ASSUME ANY LIABILITY CONCERNING THE SUITABILITY AND PROCESS ABILITY OF THE PRODUCTS, INCLUDING INDICATIONS ON PROCESS RESULTS AND OUTPUT.