

## Hot-pressing device PF-62

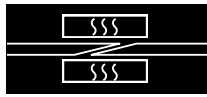



## CONTENTS

<b>0</b>	<b>INTRODUCTION .....</b>	<b>3</b>
<b>1</b>	<b>GENERAL INFORMATION.....</b>	<b>3</b>
1.1	APPLICATION .....	3
1.2	IMPORTANT SAFETY TERMS .....	3
1.2.1	General warnings .....	4
1.2.2	Personnel safety.....	4
1.2.3	Improper use .....	4
1.3	EC DECLARATION OF CONFORMITY .....	4
1.4	EC PLATES .....	6
1.5	SUPPLY CONDITIONS.....	6
1.6	AVAILABLE ACCESSORIES.....	6
<b>2</b>	<b>GENERAL MACHINE DESCRIPTION.....</b>	<b>7</b>
<b>3</b>	<b>TECHNICAL SPECIFICATIONS.....</b>	<b>8</b>
<b>4</b>	<b>OPERATING MODE.....</b>	<b>9</b>
4.1	LED INDICATOR OPERATIONS .....	9
<b>5</b>	<b>GETTING STARTED.....</b>	<b>9</b>
<b>6</b>	<b>HOT-PRESSING OF THE BELT/TAPE .....</b>	<b>10</b>
<b>7</b>	<b>MAINTENANCE .....</b>	<b>11</b>
7.1	MEASURING OF THE PLATE TEMPERATURE .....	11
7.2	ADJUSTING OF THE THERMOSTAT.....	12
7.3	REPLACEMENT OF THE POWER CORD.....	12
7.4	MALFUNCTIONING .....	13
	ACCESSORY/SPARE PART ORDERS .....	13
7.5	WARRANTY .....	13
7.6	TECHNICAL CONSULTING .....	14
<b>8</b>	<b>SYSTEM DISMANTLING AND SCRAPPING .....</b>	<b>15</b>
<b>9</b>	<b>CUSTOMER SERVICE .....</b>	<b>17</b>
<b>10</b>	<b>SPARE PARTS LIST .....</b>	<b>19</b>
10.1	PF-62/6; PF-62/8 .....	19
<b>11</b>	<b>REQUIRED ACCESSORIES .....</b>	<b>22</b>
11.1	GUIDE RAILS, CLAMPS .....	22
11.2	COOLING TONG CD-61 .....	22
11.3	PREPARING DEVICE FLEXPPOOF CUTTER AF-100/US .....	23
<b>12</b>	<b>WIRING DIAGRAMS.....</b>	<b>24</b>
12.1	WIRING DIAGRAM PF-62/8 (230V).....	24
12.2	WIRING DIAGRAM PF-62/6 (120V).....	25
<b>13</b>	<b>A1 - PREVENTIVE MAINTENANCE CHECKLIST.....</b>	<b>26</b>
<b>14</b>	<b>A2 - PREVENTIVE MAINTENANCE SUMMARY SHEET.....</b>	<b>27</b>

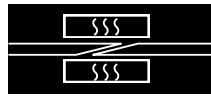

## 0 Introduction

The PF-62 is a hot pressing device for joining of Habasit power transmission belts made of thermoplastics up to a width of 60 mm and a thickness of 3,6 mm with the Flexproof method.

With cooling tong and an adjustable guide rail set you have a joining system that enables you to exchange a belt within minutes.

The wide press plate allows making 10/120 mm Flexproof finger joints for optimal strength also in situations where space is tight and visibility is poor.

The Use and maintenance manual uses PF-62 indifferently for all models:

- PF-62/6 For 120V power voltage
- PF-62/8 For 230V power voltage

## 1 General information

### 1.1 Application

The hot-pressing device PF-62 was specifically designed for rapid and safe hot-pressing of Habasit power transmission belts with the Flexproof system. Belts can be up to 60mm wide and 4.5mm thick.

The hot-pressing device PF-62 is manufactured according to recognized engineering principles and state-of-the-art technology, and complies with applicable regulations.

	<p>These operating instructions imply that all assembly, maintenance, and repair work, as well as operation of the press, be carried out by skilled personnel or monitored by responsible specialists.</p> <p>For reasons of scope, these instructions cannot cover all possible aspects of operation, maintenance, or repair. The indications given herein refer to the use of the machines according to their designated purpose by skilled personnel.</p> <p>In case of doubt or if further detailed information is required, please consult the manufacturer (see chapter "CUSTOMER SERVICE")</p>
--	---

### 1.2 Important safety terms

Symbols **ATTENTION** and **NOTE** were included in this manual.

These symbols indicate hazards or special instructions to be observed.

	<p><b>WARNING</b> Serious injury and/or serious material damages may ensue if ignored.</p>
--	--

	<p><b>INDICATION</b> Indicates important technical information that may not be known to even expert personnel.</p>
--	--

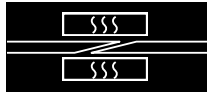

### 1.2.1 General warnings



Read all hazard warnings and operating instructions.

Failure to observe the hazard warnings and operating instructions may lead to electrical shock, fire and/or serious injury hazards.

The tool power plug must be suited to the socket. Strictly avoid modifying the plug. Do not use adapter plugs. Unmodified plugs and sockets suited for the purpose reduce electrical shock risks.

Store the tool away from rain or humidity. Water penetration in the tool increases electrical shock risk.

Do not use the cord for purposes other than those intended and, specifically, do not use it to transport or hang the tool and do not pull on it to unplug the tool.

Keep the cord away from heat, oil, sharp corners and machine parts in motion. Damages and tangled cords increase electrical shock risks.

### 1.2.2 Personnel safety

Never use the tool when tired or under the influence of drugs, alcohol or prescription medicine.

Always wear personal safety devices as well as protective gloves.

When the tool is not used, keep out of reach of children. Do not allow untrained personnel or personnel who have not read these instructions use the tool.

### 1.2.3 Improper use

The PF-62 hot-pressing device was exclusively designed for the applications described in this user manual. Inappropriate use or application for purposes other than those described in the manual are inadmissible.



Habasit is not liable for the consequences due to improper use.

Observe all the machine assembly, operating and maintenance indications as well as technical specifications! This will prevent any personal or property problems and/or damages.

QUALIFIED PERSONNEL means people authorised to perform the required operations.

These people have been sufficiently trained and have acquired experience in their field that lets them recognise and avoid hazards. They are aware of specific safety provisions and regulations.

## 1.3 EC declaration of conformity

Habasit Italiana Spa has included the EC Declaration of Conformity with the machine as per European Directive 2006/95/EC – APPENDIX III –B

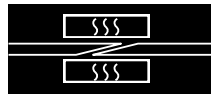

**DICHIARAZIONE DI CONFORMITÀ**

DECLARATION OF CONFORMITY

2006/95/CE – Allegato III - B



Noi <u>We</u>	
<b>HABASIT ITALIANA S.p.A.</b> Via del Lavoro, 50 I - 31016 Cordignano (TV) - ITALY	
<u>dichiariamo</u> sotto la nostra esclusiva responsabilità che il prodotto:	<i>declare under our sole responsibility that the product:</i>
<b>Dispositivo di pressatura a caldo</b>	<b>Hot pressing <u>device</u></b>
Modello:	<i>Series:</i>
<b>PF-62/6; PF-62/8</b>	
<u>è</u> conforme alle seguenti norme armonizzate:	<i>is in conformance with the following harmonized standards:</i>
DIN EN 60335-1 (VDE 0700-1):2007-02; EN 60335-1:2002+A11+A1+A12+corr.+A2:2006 DIN EN 60335-1/A13 (VDE 0700-1/A13):2009-05; EN 60335-1/A13 :2008 DIN EN 60335-2-45 (VDE 0700-45):2009-02; EN 60335-2-45:2002+A1 :2008 DIN EN 62233 (VDE 0700-366):2008-11; EN 62233 :2008 DIN EN 62233 Ber.1 (VDE 0700-366 Ber.1):2009-04; EN 62233 Ber.1 :2008	
Riconosciute dall'istituto tedesco VDE con rilascio del certificato n° 40012167 e quindi risponde alla direttiva europea 2006/95/CE	<i>Recognized by the German VDE certificate n° 40012167 and is consequently in conformity with the <u>European</u> directive 2006/95/CE</i>
Il Fascicolo Tecnico <u>viene</u> conservato presso:	<i>The Technical File is stored at:</i>
<b>HABASIT ITALIANA S.p.A.</b> Via del Lavoro, 50 I – 31016 Cordignano (TV) - ITALY	
Cordignano,	
Il Direttore Generale <i>General Manager</i>  Ugo <u>Passadore</u>	Il Responsabile della <u>Divisione Macchine</u> <i>Head of Machines and Tools Department</i>  Matteo Mapelli
.....	.....

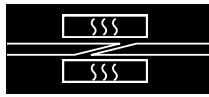

## 1.4 EC Plates

The EC plate was affixed to the machine:



## 1.5 Supply conditions

Qty.	Item
1	PF-62 hot-pressing device packed in a carton box
1	Pot magnet
1	Operating instructions

## 1.6 Available accessories



Also refer to chapter **“REQUIRED ACCESSORIES”**.

Guide rail of adjustable width, from 25 to 50 mm, including the following covering plates for 25, 30, 40, 45 belt width and 50 mm belt width and 2 metal clamps (H080672210), or from 1/2" to 2", including 1 covering plate each for the belt width 1/2", 3/4", 1", 1 1/4", 1 1/2", 1 3/4" and 2" belt width and 2 metal clamps (H080672211).



Use only Habasit guide rails. Particularly the use of metallic guide rails is not admissible. It may destroy the hot-pressing device.

- Punching device for Flexproof fingers AF-100/US
- Cooling tong CD-61

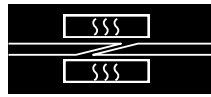

## 2 General machine description

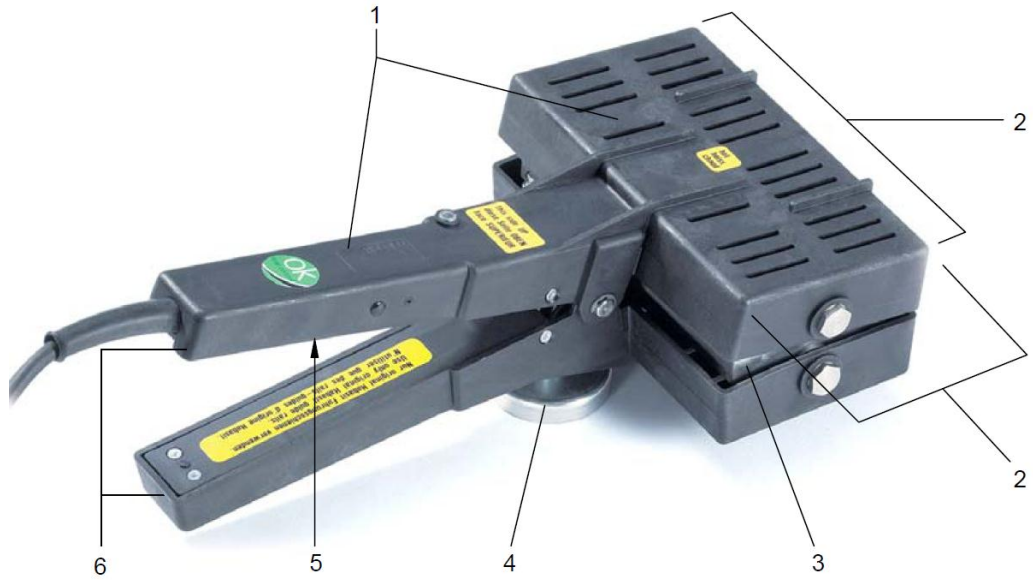

Figure: 1

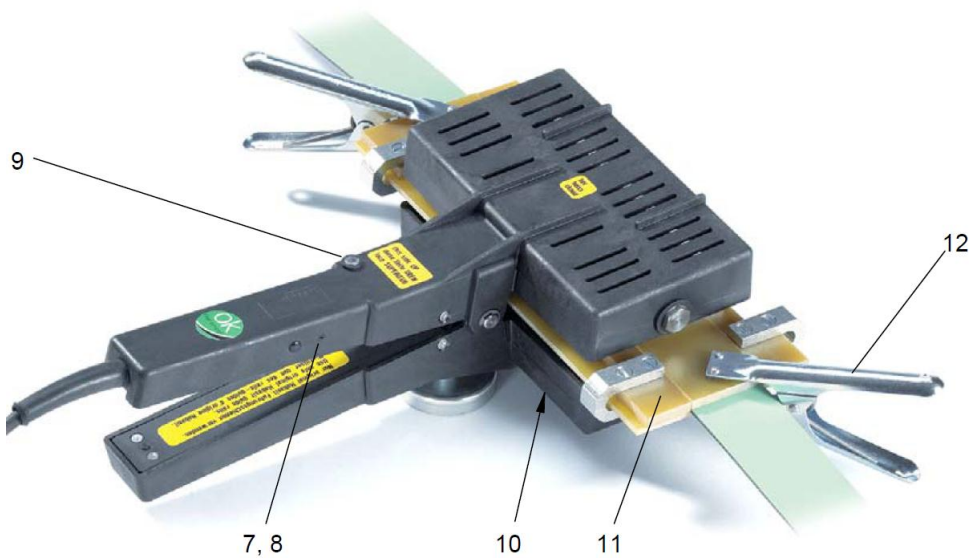
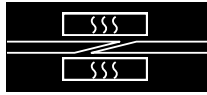

Figure: 2



Pos.	Description
1	Top side of the hot-pressing device
2	Hot-pressing zone
3	Pivoting metal heating plates
4	Pot magnet
5	Rating plate
6	Heat insulated handles
7	Adjustment potentiometer
8	Cover screw
9	Light indicator
10	Bottom side of the hot-pressing device
11	Guide rail
12	Metal clamp

### 3 Technical Specifications

Characteristics	UM	Value
<b>▪ ELECTRICAL DATA</b>		
- Rated power voltage	Vac	1x230 V (PF-62/8); 1x120 V (PF-62/6) 50 / 60Hz
- Total installed power	W	2 x 250
<b>▪ PRODUCTION</b>		
- Belt width max.	mm [inc]	60 [2,4]
- Belt thickness max.	mm [inc]	4,5 [0,18]
- Finger length for Flexproof, max.	mm [inc]	120 [4,8]
- Minimum closed belt length	mm [inc]	800 [31,5]
- Max plate temperature deviation	°C [°F]	± 3 [± 5.4]
- Heating up time to 180 °C [356 °F]	[min]	10
<b>▪ DIMENSIONS</b>		
- Dimensions ( <i>length x height x width</i> )	mm [inc]	320L x 176H x 116W [12,6L x 6,9W x 4,6H]
<b>▪ WEIGHT</b>		
- Net weight	kg [lbs]	1,8 [4]



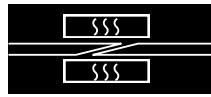

## 4 Operating mode

The hot-pressing device PF-62 functions according to the pressing-tongs principle: To open the heating plates pressed together by springs, apply substantial pressure to both handles.

Each pressing plate is heated. The lower plate comes also with a temperature sensor, the upper plate with a thermo fuse. An electronic temperature control in the handle regulates the heating plate temperature to  $180^{\circ}\text{C} \pm 2^{\circ}\text{C}$  (factory setting) even if the temperature can be adjusted within the  $120^{\circ}\text{C} / 248^{\circ}\text{F}$  a  $190^{\circ}\text{C} / 374^{\circ}\text{F}$  range. The thermo fuse protects the hot pressing device against overheating. The function of the PF-62 hot-pressing device is indicated with a light indicator in the handle.

### 4.1 Led indicator operations

The led indicator (9) on the upper handle signals hot-pressing device operating conditions:

- heating: red light.
- Set point reached and working regime: the green light blinks when the heaters are powered.

In the event of overheating over the safety limit, the safety thermostat triggers, opening contacts and the green light blinks on/off for 1 sec. See chapter “Malfunctions” for pertinent information.

## 5 Getting started

Make sure the voltage specified on the specifications plate [5] corresponds to connected mains voltage.



A tool marked 230 V can also be connected to the 220 V mains.  
Similarly, for the 120 V version, 110 V power is tolerated.

Make sure the metal pressing plates [3] are clean.

If required, screw pot magnet [4] into lower handle.

Check temperature of the heating plate. The temperature is preset at the factory at  $180^{\circ}\text{C}$ .



Safe operation is assured if the marked handle with the light indicator [9] is facing up (cable connection on the upper handle).

For fixed mode operations, place the hot-pressing device PF-62 on a stable and heat resistant base.



Do not hang up hot-pressing device by the electrical connecting cable!  
During work breaks, while hot-pressing device is connected, put it on a flat surface with the marked side facing up.

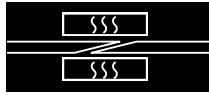

## 6 Hot-pressing of the belt/tape

Procedure: refer to the Habasit Flexproof joint guide.

- Plug in electrical connecting cable and preheat hot-pressing device.
- Preheating will take approx. 10 minutes. The light indicator [9], will change from a continuous light during heating up to intermittent light as soon as the adjusted temperature is reached.



Do not touch the hot-pressing zone.  
Keep device away from water and meltable substances.

- Open hot-pressing device by squeezing the handles [6]; and place guide rail with inserted, prepared belt ends into the hot-pressing device exactly centered, as described in the Habasit guide procedure.
- Close hot-pressing device .
- After the prescribed pressing time, remove guide rail and let it cool under pressure in a suitable device (see chapter “Cooling tong”).



After use, disconnect the hot-pressing device from the power supply and allow it to cool completely before storing it.

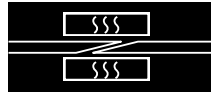

## 7 Maintenance

Always keep the hot-pressing device clean. Clean the heating plates (3) regularly and remove all material residues.



For cleaning with a cloth moistened with water or solvent, the press must be disconnected from the power supply.  
Do not reconnect to the power supply until the press is completely dry.

Periodically inspect the power supply cable and connector plug for defects (insulation damage, etc.) and rectify or replace with the correct type where necessary.

### 7.1 Measuring of the plate temperature

Check the operating temperature of the hot-pressing device once a month.

- Carry out this check in an interior room in a draft-free environment with an ambient temperature of between 18 °C and 25 °C
- Clamp sensor of temperature gauge between the heating plates (3) and heat for 5 minutes. Both plates are thus measured jointly.
- Heat up press for at least 10 minutes.
- The operating temperature has been reached when the electronic control switches the heating on and off in short intervals; The green led (9) will blink on and off with the heaters.

The temperature gauge ought to indicate  $180^{\circ}\text{C} \pm 3^{\circ}\text{C}$

If this is not the case, the temperature regulator has to be adjusted. See “Adjusting of the thermostat”



Figure 3

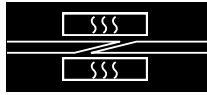

## 7.2 Adjusting of the thermostat

The maximum plate temperature of 180°C, preset at the factory, must not be exceeded the 180° reference temperature by more than 3°C. It can therefore only be adjusted with a precision temperature measuring device.



All work on the hot-pressing device involving electrical parts has to be carried out by the respective specialists only.

Observe your local laws about required training of such personnel.

The PF-62 can operate in a temperature range between 120°C / 248°F and 190°C/347°F  
If the measured temperature is not equal to the set point, adjust as follows:

- Remove cover screw [8] over adjustment potentiometer [7]
- Move adjustment potentiometer [7] of the heating control, using an insulated screwdriver, turning it ever so slightly:
  - clockwise: temperature will rise,
  - counter-clockwise: temperature will drop.
- After 5 minutes measure plate temperature to check as described above.
- Proceed carefully and adjust gradually. Observe temperature change.
- Re-cover adjustment potentiometer [7] with cover screw [8].



Make sure not to let the temperature rise above 195°C / 383°F during adjustment. Excessive temperatures may damage the hot-pressing device or blow the thermo fuse.

## 7.3 Replacement of the power cord

Check power cord periodically. In case of damage replace with the same type (H05-RNF). To make sure only skilled staff will do this repair, special tools are required for this operation.



All work on the hot-pressing device involving electrical parts has to be carried out by the respective specialists only.

Observe your local laws about required training of such personnel.

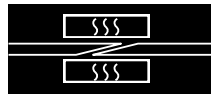

## 7.4 Malfunctioning

The led indicator on the upper handle signals hot-pressing device operating conditions:

Indicator light	Description
<b>ON; red light</b>	The pressing device is heating the plates. Set point temperature has not yet been reached.
<b>Blinking; green light</b>	The pressing device is at working regime; the led turns on and off with the heaters.
<b>Blinking green light every 1 sec</b>	Overheating. The temperature is over 200°C / 392°F. The pressing device does not operate correctly. Turn off and unplug the pressing device and wait until it cools (under 100°C/ 212°F). This resets the alarm. Plug the pressing device in and check if it works correctly. If the safety thermostat triggers, opening contacts, unplug the device and wait until it fully cools. Plug the device in and check operations. Contact your dealer if the problem persists.

### Accessory/spare part orders

Spare parts and accessories can be directly ordered from the manufacturer at the following address:

**Habasis Italiana S.p.A.**  
Via del Lavoro, 50.  
**31016 CORDIGNANO (TV) - ITALY**  
Phone: +39 0438 9113  
Fax: + 39 0438 912374  
E-mail : [info@habasit.it](mailto:info@habasit.it)  
Internet : [www.habasit.com](http://www.habasit.com)

Please clearly specify ordered part codes.

Enter codes based on Drawings (see chapter "SPARE PARTS") and, if possible, the power voltage required for mains connection.



The use of other branded spare parts that do not meet Habasis specifications is prohibited. Habasis is not liable for the use of non-original Habasis spare parts.

## 7.5 Warranty

All tools are subject to attentive final inspection. They are guaranteed free of material and factory defects for 1 year provided they are used correctly.

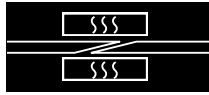

## **7.6 Technical consulting**

Our experts are available for all consultations. For technical questions concerning Hot-pressing device operations and conditions, contact the manufacturer at the address listed above.

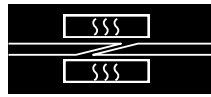

## 8 System dismantling and scrapping

The press must be uninstalled by HABASIT Assistance Service technicians or authorized HABASIT technicians with experience in:

- Machine assembly/disassembly
- Assembly/disassembly of the electrical, pneumatic and hydraulic plant, consulting the corresponding diagrams.

Generally the press is only decommissioned and dismantled when replaced.

This operation may be performed by specialised companies or the owner; in any case, current regulations must be observed.

If demolished by the user's personnel, the various parts must be separated by type and specialised (and authorised) companies employed for the disposal of the various products.

We would like to remind you that the most important materials used in machine construction are:

- Steel
- Aluminium
- Electrical wires
- Plastic materials
- Rubber

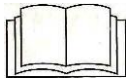

Habasis Italiana Spa has adopted suitable measures to reduce the disposal of RAEE generated by the use of AEE incorporated in its machines in order to reduce RAEE as mixed solid waste to a minimum, to ensure the correct processing and high level of RAEE separate waste collection.

Habasis collects the RAEE generated by its production, maintenance and customer service activities as per Directive 2012/19/EU article 13.

In order to reduce the presence of hazardous substances when recycling new AEE, Habasis requests suppliers comply with Directive 2012/19/EU and accompany AEE with an explicit declaration of conformity to Directive 2002/95/EC (RoHS).



This machine was designed and constructed with recyclable materials and components.

If demolished by the customer's staff, the various components must be separated by type.

RAEE must be collected separately (art. 3-h) and discarded according to art. 6 in directive 2012/19/EU.



### ATTENTION!

Before carrying out any kind of work on the machine it is essential to ensure that the plant (electrical, pneumatic and water) is disconnected from energy supplies, that the pneumatic and water plant is properly depressurized and that there is no remaining potential energy in the moving parts.

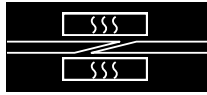

**ATTENTION!**

Follow the following disconnection procedure:

- Disconnect the electrical circuit
- Carry out mechanical disassembly.

If the press is stored for a certain period of time, prepare it as indicated in the following section. If it must be immediately move, refer to the specific section.



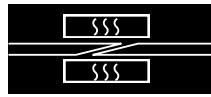

## 9 Customer service

For any further clarifications, contact Habasis Italiana S.p.A. customer service at the following address:

**Habasis Italiana S.p.A.**  
Via del Lavoro, 50.  
**31016 CORDIGNANO (TV) - ITALY**  
Phone: +39 0438 9113  
Fax: + 39 0438 912374  
E-mail : [info@habasis.it](mailto:info@habasis.it)  
Internet : [www.habasis.com](http://www.habasis.com)

---

### Product liability, application considerations

The proper selection and application of Habasis products, including the related area of product safety, is the responsibility of the customer.

All indications / information are recommendations and believed to be reliable, but no representations, guarantees, or warranties of any kind are made as to their accuracy or suitability for particular applications. The data provided herein are based on laboratory work with small-scale test equipment, running at standard conditions, and do not necessarily match product performance in industrial use. New knowledge and experiences can lead to modifications and changes within a short time without prior notice.

BECAUSE CONDITIONS OF USE ARE OUTSIDE OF HABASIT'S AND ITS AFFILIATED COMPANIES CONTROL, WE CANNOT ASSUME ANY LIABILITY CONCERNING THE SUITABILITY AND PROCESS ABILITY OF THE PRODUCTS MENTIONED HEREIN. THIS ALSO APPLIES TO PROCESS RESULTS / OUTPUT / MANUFACTURING GOODS AS WELL AS TO POSSIBLE DEFECTS, DAMAGES, CONSEQUENTIAL DAMAGES, AND FURTHER-REACHING CONSEQUENCES

---

This use and maintenance manual and its attachments are translated from original language (Italian).

---

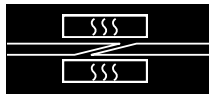

## Hot-pressing device PF-62



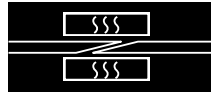

## 10 Spare parts list

### 10.1 PF-62/6; PF-62/8

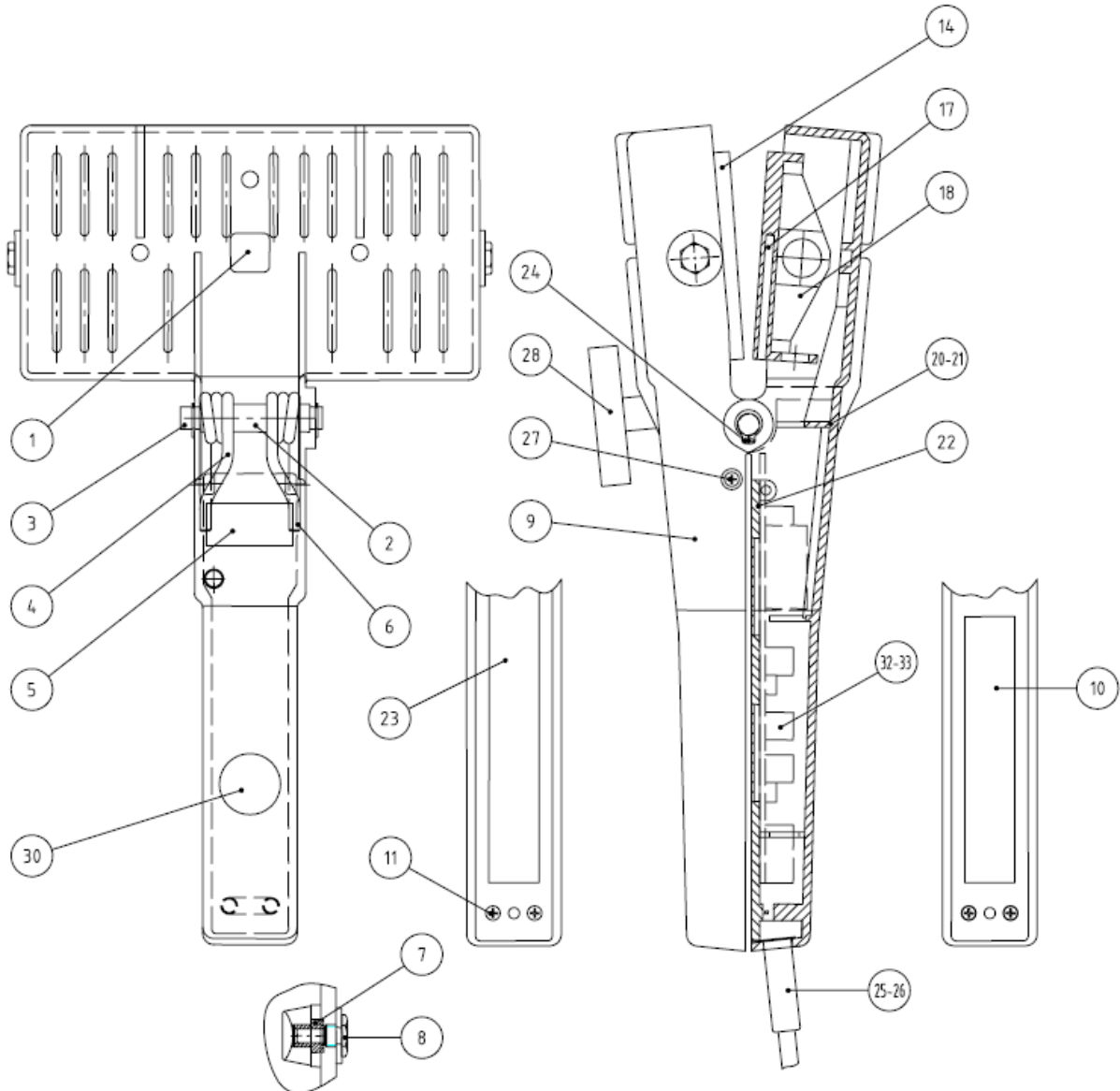

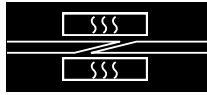

POS.	CODE	DESCRIPTION
	<b>H080691220</b>	<b>PF-62/6</b>
	<b>H080691240</b>	<b>PF-62/8</b>
1		
2	H080700017	SPACER TUBE PQ/PT PRESSES
3	H080700007	PIN FOR SPRINGS PQ/PT
4	H080700004	LEFT SPRING FOR PQ/PT/PF PRESSES HANDLE
5		
6	H080700003	RIGHT SPRING FOR PQ/PT/PF PRESSES HANDLE
7	H080702000	P-0272000 BUSH TEFLON/CARBON
8		
9	H080702004	LOWER HANDLE PF-62
10		
11		
12	H080704003	CORD H05RNF 3X0.75 EURO
13	H080704007	CORD SJO 3X18 AWG USA
14	H080709509	P-0492000 LOWER HEATING PLATE GROUP PF-62
15		
16		
17	H080709514	NTC 220KOHM ASSEMBLED SENSOR
18	H080709510	P-0493000 UPPER HEATING PLATE GROUP PF-62
19		
20	H080702008	P-0267000 UPPER HANDLE PF-62 USA
21	H080702007	P-0267000 UPPER HANDLE EURO/CH
22	H080702002	PQ/PT PRESSES HANDLE COVER
23		
24		
25	H080704757	BLACK HOSE FITTING NZ76 USA
26	H080704756	BLACK HOSE FITTING EURO/CH
27		
28	H080700002	P-0871000 PRESS MAGNET

Part codes in the drawing but not in the spare parts list should be expressly requested from:

## Habasit Italiana S.p.A.

Via del Lavoro, 50.

**31016 CORDIGNANO (TV) - ITALY**

Phone: +39 0438 9113

Fax: + 39 0438 912374

E-mail : [info@habasit.it](mailto:info@habasit.it)

Internet : [www.habasit.com](http://www.habasit.com)

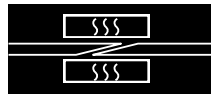

Heating plate

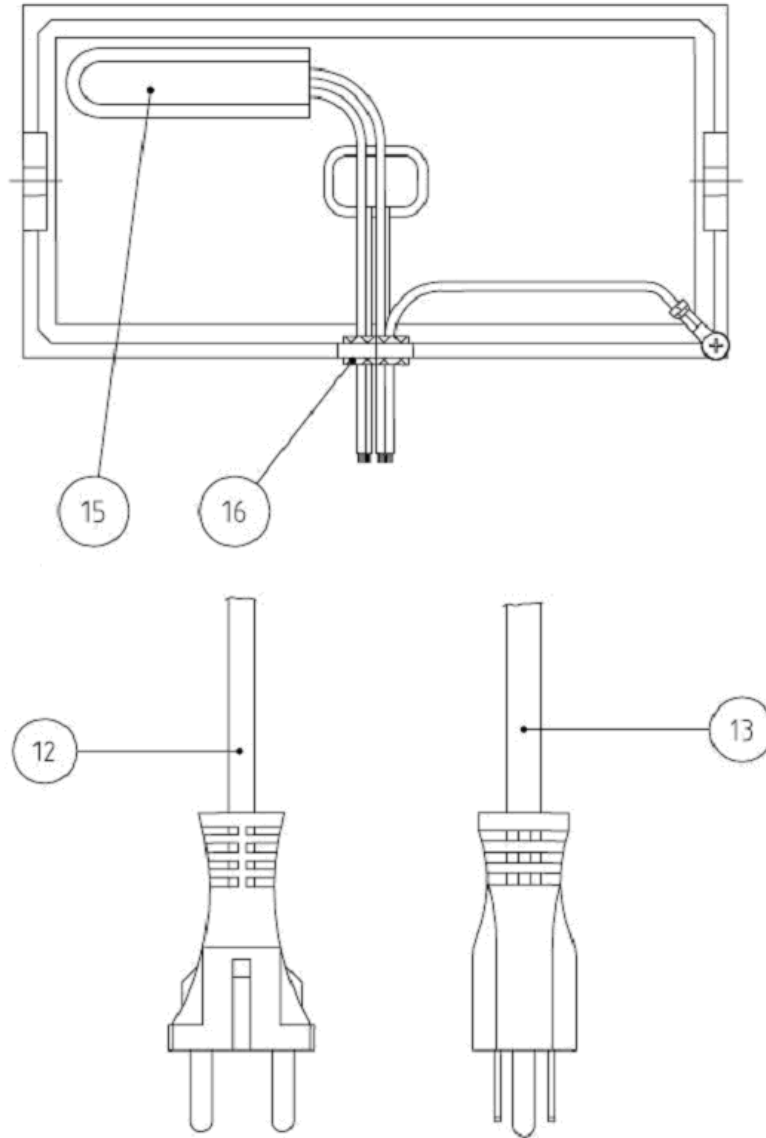

	H080691220	PF-62/6
	H080691240	PF-62/8
<b>POS.</b>	<b>CODE</b>	<b>DESCRIPTION</b>
12	H080704003	CORD H05RNF 3X0.75 EURO
13	H080704007	CORD SJO 3X18 AWG USA
15		
16		
29		

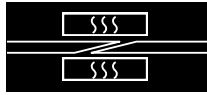

## 11 Required accessories

### 11.1 Guide rails, clamps

- These accessories are necessary for producing perfect fusion joints.
- Once the tape ends have been inserted into the corresponding guide rail (see Figure 4) and fixed in place with the covering plate, the two clamps are applied at an angle so as to prevent the tape from shifting during the hot-pressing process.
- Place the guide rail in the precise center of the open hot-pressing device and close (see Figure 5). This assures uniform distribution of the heat to guide rail and joining area.

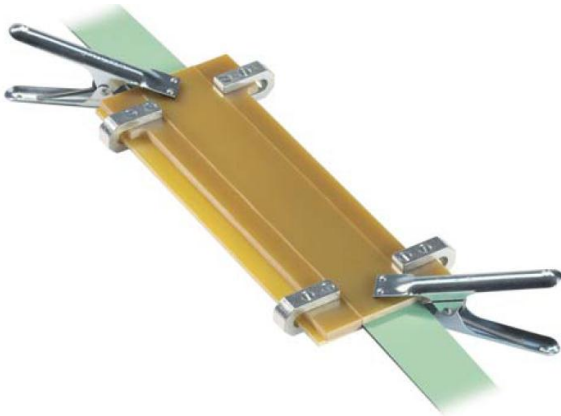

Figure: 4



Figure: 5

### 11.2 Cooling tong CD-61

- The cooling tong CD-61 is designed for the rapid cooling of the joint, still within the guide rail (see Figure 6). After the specified pressing time has elapsed, the cooling tong must be clamped onto the guide rail as quickly as possible.
- If the cooling tong is used repeatedly at short intervals, they get warm. They may be cooled by dipping them in cold water.

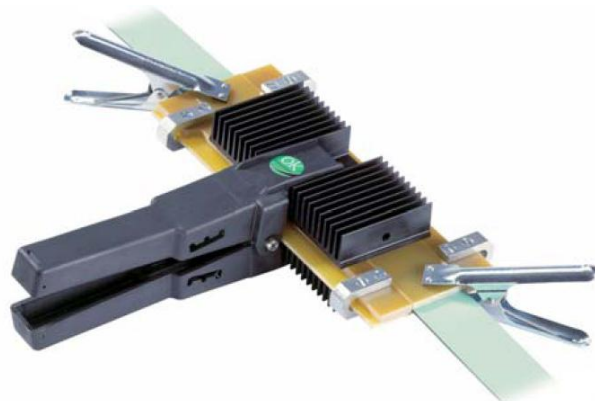
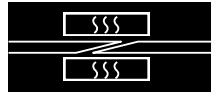

Figure: 6



### 11.3 Preparing device Flexproof cutter AF-100/US

The AF-100/US is a device for preparing Habasit belts and tapes up to a width of 100 mm and a thickness of 6 mm for Flexproof (finger) joints. It is available in several versions. Each version can be converted to the other with a conversion set.

- AF-100/US-35 for 10/35 finger geometry
- AF-100/US-80 for 10/80 finger geometry
- AF-100/US-120 for 10/120 finger geometry.

The belt is securely clamped on a movable carriage. This carriage is positioned in steps of 10 mm (finger pitch) under a die-cutting head. The die-cutting head, with two knife blades, is then actuated with an eccentric lever, providing enough force to cut even the strongest Aramid fabrics with ease.

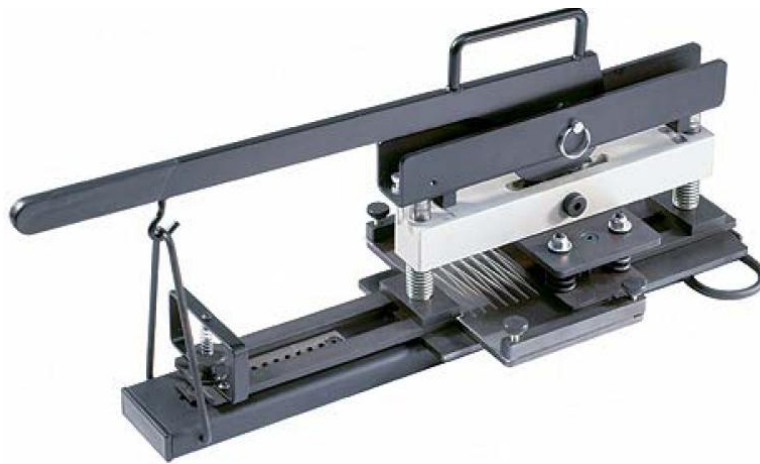
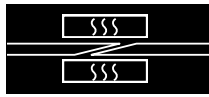
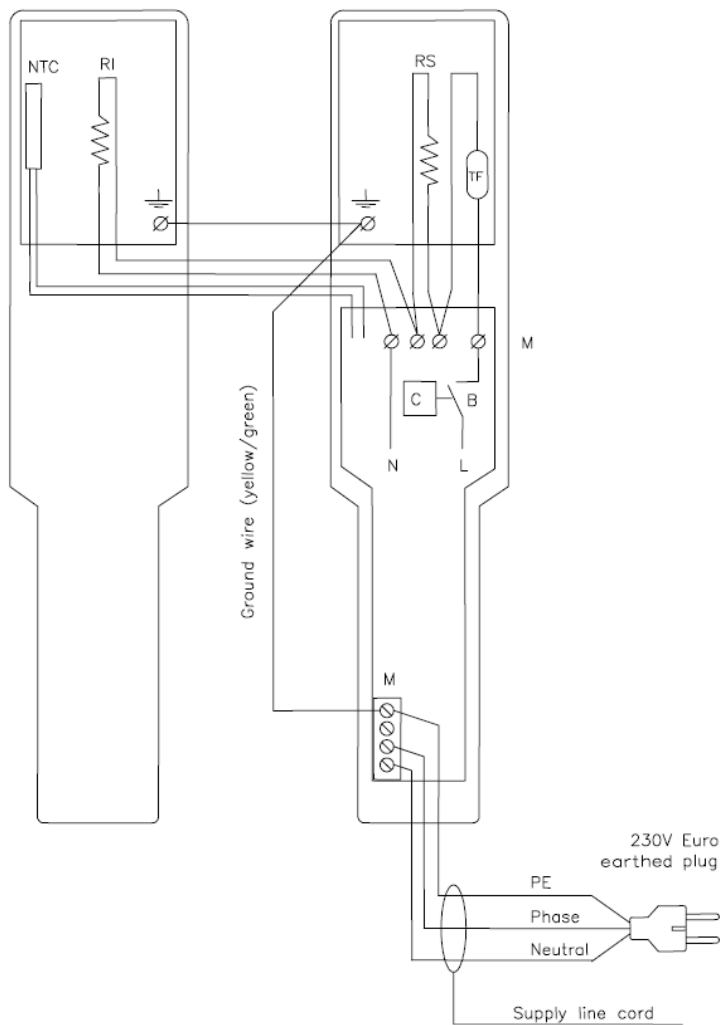

Figure: 7



## 12 Wiring diagrams

### 12.1 Wiring diagram PF-62/8 (230V)



<b>NTC</b>	NTC temperature sensor		<b>M1</b>	4-pole power terminal
<b>RI</b>	Lower plate heater		<b>N</b>	Neutral line
<b>RS</b>	Upper plate heater		<b>C</b>	Electronic control
<b>TF</b>	Thermo fuse		<b>B</b>	Relay with contact (normally open)



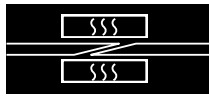

## 12.2 Wiring diagram PF-62/6 (120V)

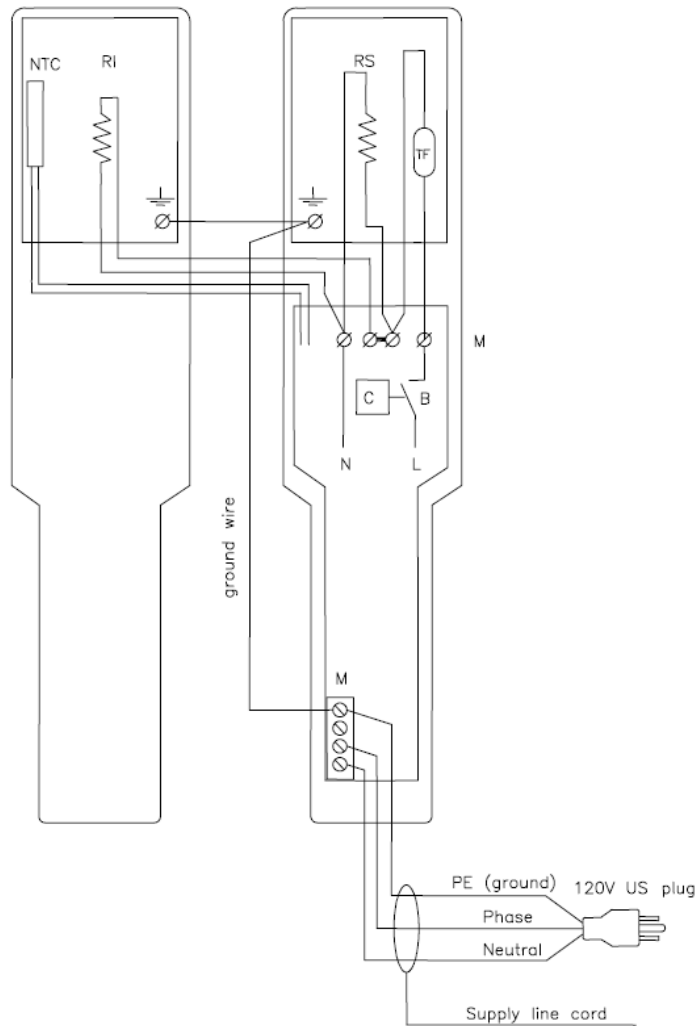

<b>NTC</b>	NTC temperature sensor		<b>M1</b>	4-pole power terminal
<b>RI</b>	Lower plate heater		<b>N</b>	Neutral line
<b>RS</b>	Upper plate heater		<b>C</b>	Electronic control
<b>TF</b>	Thermo fuse		<b>B</b>	Relay with contact (normally open)

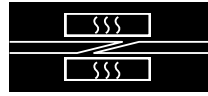

## 13 A1 - Preventive maintenance checklist

Job positions: A: Machine operator  
 B: Maintenance technician

Work to be performed (for additional information and reference numbers, see user manual)	Daily	Frequency Periodic (monthly)			Spare part code Evaluation criteria
		1	6	Note	
<b>1. Cleaning</b>					
1.1 Clean the machine after use removing residue deposits	A				
<b>2. Inspect the power cord</b>					
2.1 Inspect the cord and plug to ensure there are no defects		B			Insulation damaged, Defective connections
<b>3. Measure heating plate temperature</b>					
3.1 Proceed as thoroughly indicated in user manual chapter "MAINTENANCE"		B			

Observations and notes:

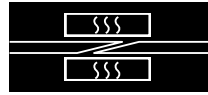

## 14 A2 - Preventive maintenance summary sheet

Machine type:

Machine nr.:

Start date:

Actions – see checklist (daily unrecorded work)	check	completed		check	completed		check	completed		check	completed	
	next	approval	date	next	approval	date	next	approval	date	next	approval	date
2.1 Check for cord damages												
3.1 Measure heating plate temperature												

Observations, repairs: