

HOT PRESS

Type : PM-1056/160

GENERAL MANUAL USE AND MAINTENANCE



ORDER :

S.N. :

Habasit Italiana S.p.A. - Via A. Meucci 8 Zona Industriale - I - 31029 Vittorio Veneto

This document is the property of HABASIT ITALIANA and, therefore, must not be passed on to persons or Bodies outside the sphere of the Company unless previously authorized by the Technical Department for Industrial and Quality Systems.

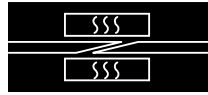

FOREWORD

IMPORTANT

BEFORE INSTALLING, SETTING UP AND OPERATING THE MACHINE, THE CUSTOMER MUST CAREFULLY READ THIS MANUAL AND CAREFULLY FOLLOW THE INSTRUCTIONS IT CONTAINS IN ORDER TO ENSURE THE MACHINE IS USED SAFELY AND CORRECTLY. ALL OPERATORS AND/OR MAINTENANCE PERSONS MUST KNOW THIS MANUAL TO ENABLE THEM TO WORK SAFELY ON THE MACHINE.

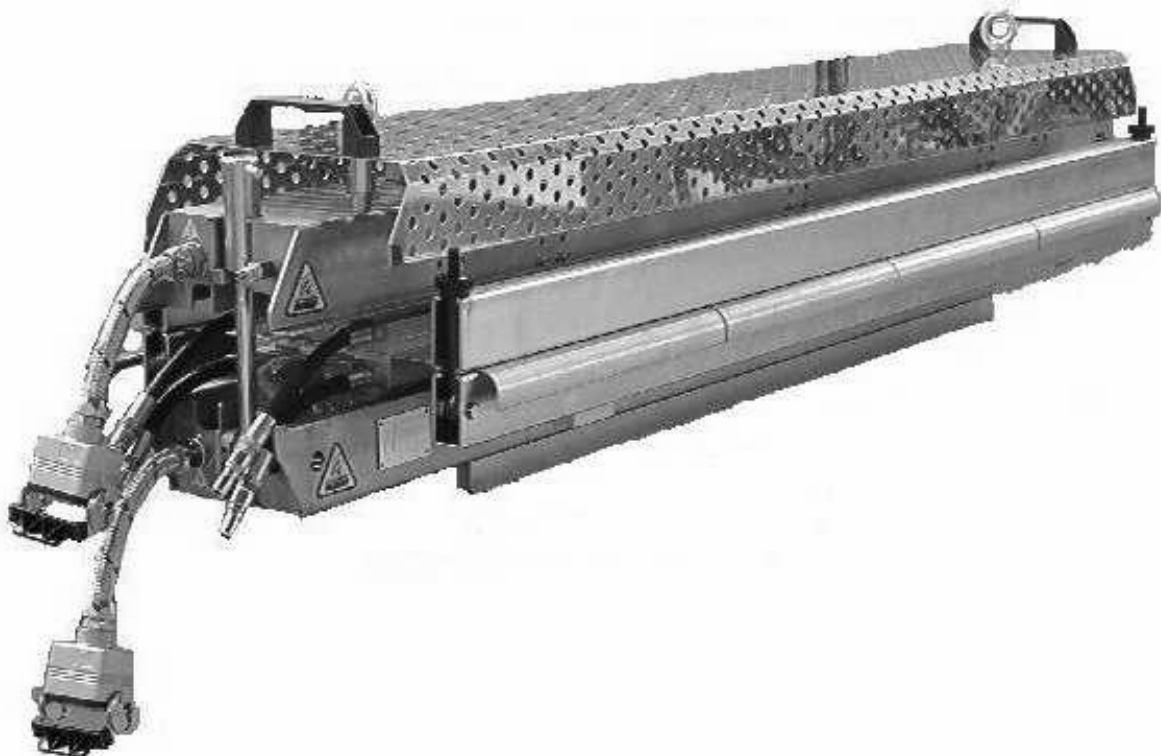



SUMMARY

SECTION A - REGULATIONS AND GENERAL WARNING NOTES.....	A-1
SECTION A.1 READING ASSISTANCE NOTES	A-2
SECTION A.2 HOW THE MANUAL IS ORGANIZED.....	A-3
SECTION A.3 USE CRITERIA	A-4
SECTION A.4 GUARANTEE CONDITIONS	A-5
Section. A.4.1 Guarantee terms and validity	A-5
Section. A.4.2 When the guarantee can be voided	A-5
SECTION A.5 VISUAL SIGNS	A-6
Section. A.5.1 Signs	A-6
SECTION A.6 SAFETY WARNINGS	A-10
SECTION A.7 REMAINING RISKS.....	A-11
SECTION A.8 QUALIFICATIONS OF PERSONNEL.....	A-12
SECTION A.9 REFERENCES AND STANDARDS.....	A-13
Section. A.9.1 Applicable EU Directives.....	A-13
Section. A.9.2 EU Directives concerning safety in the workplace	A-13
Section. A.9.3 EU Directives concerning personal protection	A-13
Section. A.9.4 Community directives on the protection of the environment.....	A-13
SECTION B - TECHNICAL SPECIFICATIONS.....	B-1
SECTION B.1 PURPOSE OF THE MACHINE.....	B-2
SECTION B.2 PRESS IDENTIFICATION DATA.....	B-3
SECTION B.3 TECHNICAL CHARACTERISTICS OF THE PRESS.....	B-4
SECTION B.4 EQUIPMENT AND ACCESSORIES PROVIDED	B-6
Section. B.4.1 Necessary accessories for fixed use	B-6
Section. B.4.2 Necessary accessories for mobile use	B-7
Section. B.4.3 Regulating unit options.....	B-8
Section. B.4.4 Control unit options	B-9
Section. B.4.5 Optional accessories for both fixed and mobile use	B-9
SECTION B.5 ORDERING ACCESSORIES/SPARE PARTS	B-10
SECTION C - INSTALLATION.....	C-1
SECTION C.1 PREPARATION OF WORK SITE	C-2
SECTION C.2 PACKING AND HANDLING.....	C-3

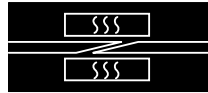

Author: A.T.
Edition: 09/2004
Replaces:

INDEX
Page 5

Section. C.2.1 First delivery / FIXED OPERATION use	C-3
Section. C.2.2 MOBILE OPERATION handling.....	C-4
SECTION C.3 ASSEMBLING AND INSTALLATION	C-5
Section. C.3.1 Positioning.....	C-5
Section. C.3.2 Connection of air and water supplies.....	C-5
Section. C.3.3 Electrical connection	C-6
SECTION C.4 DISASSEMBLY OF THE MACHINE	C-7
SECTION C.5 STORAGE	C-8
SECTION C.6 DISPOSAL	C-9
SECTION D - OPERATION	D-1
SECTION D.1 GENERAL WARNINGS	D-2
SECTION D.2 GUARDS INSTALLED	D-3
SECTION D.3 PRESS PARTS IDENTIFICATION	D-5
Section. D.3.1 View of PM-1056/160.....	D-5
Section. D.3.2 Main elements of the PM-1056/160	D-6
Section. D.3.3 Compressed air connections	D-7
SECTION D.4 MACHINE CONFIGURATION	D-8
Section. D.4.1 Fixed operation use.....	D-8
Section. D.4.2 Mobile operation use.....	D-10
SECTION D.5 PRESS OPERATION.....	D-11
Section. D.5.1 Fixed and mobile operation working	D-11
Section. D.5.2 Working cycles	D-11
Section. D.5.3 Fixed operation use.....	D-11
Section. D.5.4 Mobile operation use.....	D-13
Section. D.5.5 Notes on use	D-14
Section. D.5.6 Technical assistance	D-14
SECTION D.6 TROUBLESHOOTING.....	D-15
SECTION E - ORDINARY MAINTENANCE.....	E-1
SECTION E.1 GENERAL.....	E-2
SECTION E.2 GENERAL WARNINGS.....	E-3
SECTION E.3 ROUTINE AND SCHEDULED MAINTENANCE	E-4
Section. E.3.1 Preliminary operations	E-4
SECTION F - EXTRAORDINARY MAINTENANCE.....	F-1
SECTION F.1 EXTRAORDINARY MAINTENANCE	F-2

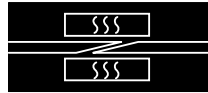

Author: A.T.
Edition: 09/2004
Replaces:

INDEX
Page 6

Section. F.1.1 Adjustments, replacements and synchronization	F-2
SECTION G - ELECTRICAL, WATER AND COMPRESSED AIR SYSTEM.....	G-1
SECTION G.1 ELECTRICAL, WATER AND COMPRESSED AIR SYSTEM	G-2
SECTION H - GLOSSARY.....	H-3
SECTION H.1 GLOSSARY OF TERMS.....	H-4
SECTION I - SPARE PARTS.....	I-1
SECTION I.1 INTERNAL SPARE PARTS	I-2
SECTION I.2 PRESSER CUSHION SPARE PARTS.....	I-4
SECTION I.3 EXTERNAL SPARE PARTS	I-6
SECTION I.4 BELT LOCKING SYSTEM SPARE PARTS.....	I-8
SECTION I.5 SPARE PARTS FOR COMPRESSED AIR CONNECTION.....	I-10
SECTION I.6 SPARE PARTS FOR ELECTRICAL, WATER AND COMPRESSED AIR CONNECTIONSI-11	
SECTION J - ANNEXED COMMERCIAL DOCUMENTS.....	J-1
SECTION J.1 WATER CIRCULATION PUMP.....	J-2
SECTION J.2 PORTABLE COMPRESSOR	J-3

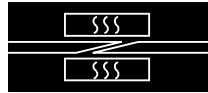

SUMMARY OF THE FIGURES

FIGURE 1 - MACHINE IDENTIFICATION PLATE	B-3
FIGURE 2 - POSITION OF SIGNS ON THE PRESS	D-4
FIGURE 3 - VIEW OF PM 1056/160	D-5
FIGURE 4 - MAIN ELEMENTS OF THE PM 1056/160	D-6
FIGURE 5 - COMPRESSED AIR CONNECTIONS	D-7
FIGURE 6 - FIXED OPERATION USE WITH PMR-06 AND PMC-04	D-8
FIGURE 7 - FIXED OPERATION USE WITH PMR-06 AND PMC-06	D-9
FIGURE 8 - MOBILE OPERATION USE WITH PMR-06	D-10
FIGURE 9 - PRESS WIRING LAY-OUT PM-1056/160	G-2
FIGURE 10 - INTERNAL SPARE PARTS	I-2
FIGURE 11 - PRESSER CUSHION SPARE PARTS	I-4
FIGURE 12 - EXTERNAL SPARE PARTS	I-6
FIGURE 13 - BELT LOCKING SYSTEM SPARE PARTS	I-8
FIGURE 14 - SPARE PARTS FOR COMPRESSED AIR CONNECTION	I-10

SUMMARY OF TABLES

TABLE 1 - DANGER SIGNS	A-7
TABLE 2 - PRESCRIPTIVE SIGNS	A-7
TABLE 3 - TERMS AND DEFINITIONS	A-8
TABLE 4 - QUALIFICATIONS	A-12
TABLE 5 - ELECTRICAL CHARACTERISTICS	B-4
TABLE 6 - PNEUMATIC CHARACTERISTICS	B-4
TABLE 7 - WATER CHARACTERISTICS	B-4
TABLE 8 - DIMENSIONS AND ENVIRONMENTAL CHARACTERISTICS	B-5
TABLE 9 - CHARACTERISTICS OF WORKABLE ELEMENTS	B-5
TABLE 10 - NECESSARY ACCESSORIES FOR FIXED USE	B-6
TABLE 11 - ACCESSORIES NECESSARY FOR MOBILE USE	B-7
TABLE 12 - REGULATING UNIT OPTIONS (PMR-XX) (PRESS-XX COMBINATIONS)	B-8
TABLE 13 - CONTROL UNIT OPTIONS (PMC-XX) (PMR-XX – PMC-XX COMBINATIONS)	B-9
TABLE 14 - OPTIONAL ACCESSORIES (FOR BOTH FIXED AND MOBILE USE)	B-9
TABLE 15 - STORAGE CONDITIONS	C-8

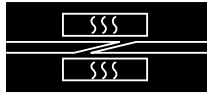

Author: A.T.
Edition: 09/2004
Replaces:

INDEX
Page 8

TABLE 16 - TROUBLESHOOTING	D-15
TABLE 17 - PERIODIC MAINTENANCE WORK	E-5
TABLE 18 - GLOSSARY	H-4
TABLE 19 - SPARE PARTS AND INTERNAL PARTS	I-3
TABLE 20 - SPARE PARTS AND PRESSER CUSHION	I-5
TABLE 21 - EXTERNAL SPARE PARTS.....	I-7
TABLE 22 - BELT LOCKING SYSTEM SPARE PARTS (CODE 006D1000)	I-9
TABLE 23 - SPARE PARTS FOR COMPRESSED AIR CONNECTION (CODE 008E1000).....	I-10
TABLE 24 - SPARE PARTS FOR ELECTRICAL, WATER AND AIR CONNECTIONS USED IN FIXED OPERATION	I-11
TABLE 25 - SPARE PARTS FOR ELECTRICAL, WATER AND AIR CONNECTIONS USED IN MOBILE OPERATION.....	I-12



SECTION A - REGULATIONS AND GENERAL WARNING NOTES

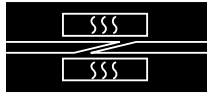

SECTION A.1 READING ASSISTANCE NOTES

Meanings of notes used in this manual:

ATTENTION

Note of particular interest for the safety of the people running and maintaining the machine.

WARNING

Note of particular interest concerning the safety of the machine.

NOTE

A request for the reader's attention referred to the subsequent paragraph.

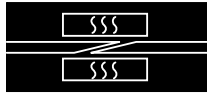

SECTION A.2 HOW THE MANUAL IS ORGANIZED

This machine was designed, built and tested by expert technicians. The high quality materials used to build the machine make it operationally highly reliable. For further, more detailed information or in regard to problems, please contact our headquarters at the following address:

Habasit Italiana S.p.A.
Via A. Meucci 8
Zona Industriale
I - 31029 Vittorio Veneto
Tel.: 0039.(0)438.9113
Fax: 0039.(0)438.200545

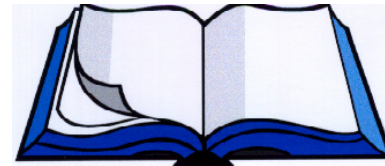

This manual observes the organizational rules and requirements of Directive 98/37/CE, duly amended, being the Directive of the Council of the European Community of 14 June 1989, concerning the reconciliation of the laws of member states regarding machines, also known as the «Machine Directive», and also all the other Directives and Regulations referred to in the said Machine Directive, inspired by criteria which, in addition to illustrating the technical characteristics of the machine and its use, maintenance and troubleshooting methods, also clearly indicate the following:

All the protection measures adopted on the machine, fully integrating design safety planning and construction safety

All protection measures to be adopted to meet those risks that cannot be completely eliminated

All indications for the training of personnel using the machine, while indicating where it is necessary to provide for individual safety protection devices.

The manual is divided up into sections. Each section deals with a specific subject in which every aspect of safety is considered and clearly highlighted in the text.

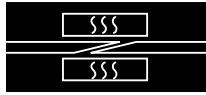

SECTION A.3 USE CRITERIA

HABASIT requests the Customer to fully read this manual on delivery of the machine it accompanies, and always before attempting any action on the machine. This manual is arranged to supply all the instructions, indications and warnings the user may need in order to know the machine, understand its operating principles, and to be adequately informed to ensure safe use.

In addition to the instructions in this manual, we would ask users to observe any specific current laws.

This manual must be considered as an essential part of the machine. Its contents must be made known to the entrusted maintenance persons and users.

The purpose is to provide all the information required for good, correct use of the machine.

The manuals must be kept throughout the machine's life and must be updated in the event of modifications aimed at improving the machine's performance.

The manuals must be available to qualified personnel.

Consultation of this manual is facilitated by the general index on the first page, which makes it possible to immediately find the subject of interest.

If the subject dealt with is particularly important it is highlighted with references to the type of technical personnel required to intervene.

All updates HABASIT considers necessary to improve the quality of the machine will be communicated by way of sending of further specific documentation or a new manual to replace the previous one.

If the machine is sold to another customer, the manuals must accompany the machine and the new customer must be notified to HABASIT for any future modifications and updates.

A copy of this manual, delivered with the machine, is meant for the maintenance operators, who shall read and keep it near the machine, and consult it before undertaking any action on the machine.

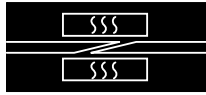

SECTION A.4 GUARANTEE CONDITIONS

Section. A.4.1 GUARANTEE TERMS AND VALIDITY

The manufacturer guarantees the product against any faults either in materials or in workmanship, for 1 (one) year from the date of installation of the product at the Buyer's premises. In this case, the manufacturer shall limit itself to replacing or repairing any part or parts returned to the manufacturer, which was/were found to be faulty.

The manufacturer may, at his own discretion, also replace or repair any part or parts of the product being repaired that is/are felt to be defective.

The manufacturer shall have the sole right to decide if such parts should be repaired or replaced.

The manufacturer shall not be liable in any other case for collateral or incidental damage.

The guarantee does not apply to plant that has been repaired by third parties that have NOT been authorized by the manufacturer.

Spare parts supplied by the manufacturer must be used. Any deviation from this rule will mean the guarantee will not apply

Section. A.4.2 WHEN THE GUARANTEE CAN BE VOIDED

The manufacturer's guarantee for the plant and associated equipment may be annulled as a result of improper intervention or repairs.

The manufacturer's guarantee for the equipment may be annulled as a result of the use of improper materials or materials not supplied by the manufacturer.

This manual's instructions must be observed or the guarantee cover will be lost.

IMPORTANT

HABASIT CANNOT BE HELD RESPONSIBLE FOR ANY DAMAGE CAUSED BY IMPROPER, INCORRECT AND UNREASONABLE USE OF THE MACHINE.

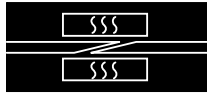

Author: A.T.
Edition: 09/2004
Replaces:

REGULATIONS AND GENERAL WARNING NOTES

Page **A-6**

SECTION A.5 VISUAL SIGNS

ATTENTION

Visual signs – indicator notices – are applied to the machine. A knowledge of their meaning helps ensure that safety regulations are observed, prevent accidents, and assure good operation.

All people approaching the machine must have a clear understanding of the symbol and its meaning. Non observance may cause accidents entailing damage to personnel and to the machine.

Section. A.5.1 SIGNS

The signs affixed to the machine are shown below; the following signs may be located on the machine; such signs enable staff operating or working on the machine to know about and so prevent the dangers and risks of not observing the principal safety rules.

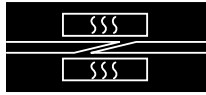

Author: A.T.
 Edition: 09/2004
 Replaces:

REGULATIONS AND GENERAL WARNING NOTES

Page **A-7**

TABLE 1 - DANGER SIGNS







	<p>Attention: DANGER OF ELECTRIC SHOCKS Notify the personnel involved that, if the described operation is not performed while observing safety regulations, there is a risk of suffering an electric shock.</p>
	<p>Attention: DANGER OF CRUSHING OF OR INJURIES TO HANDS AND FINGERS Indicates the presence of materials which can cause damage to the limbs.</p>
	<p>Attention: HIGH TEMPERATURE PARTS Indicates the presence of very hot materials which could cause burns.</p>

TABLE 2 - PRESCRIPTIVE SIGNS

	<p>General obligation An obligation to carry out the operation as described and in accordance with safety rules so as avoid risks and accidents. This is usually accompanied by notices explaining the obligation.</p>
	<p>Obligation to use protective gloves Use of protective gloves by the operator, as the risk of hand injuries is implicit.</p>
	<p>Obligation to use protective shoes Use of protective shoes by the operator as the risk of slipping, perforation or crushing of feet is implicit.</p>
<p>Vorsicht! Nur geschlossene Presse unter Druck setzen (max 3 bar)</p> <p>Caution! Pressurize only when press is closed (max 42 psi)</p> <p>Attention! Ne mettez sous pression que lorsque (max 3 bar)</p>	<p>Maximum usable pressure warning Indication of maximum pressure that can be applied to the presser cushion</p>

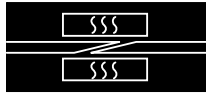

Author: A.T.
 Edition: 09/2004
 Replaces:

REGULATIONS AND GENERAL WARNING NOTES

Page **A-8**

TABLE 3 - TERMS AND DEFINITIONS

TERM	DEFINITION	ABBREV.
PROTECTION DEVICES	Safety measures involving the use of specific technical means called protection devices (guards, safety devices) to protect persons from dangers that cannot be reasonably eliminated or sufficiently reduced in the design of the machine.	
GUARD	A part of the machine specifically used to provide protection by the use of a physical barrier. Depending on how it is made, a guard may be called a cowling, cover, screen, door or fence etc. Note 1 - A guard may act: - alone; in which case it is effective only when closed - associated with a locking device with or without locking the guard; in this case protection is assured whatever the position of the guard. Note 2 - «Closed» means, in the case of a fixed guard, «kept in position»	
FIXED GUARD	Guard kept in position (i.e. closed), by means of a fastening (screws, bolts etc.) that make its removal/opening impossible without the use of tools	FG
MOBILE GUARD	Guard that is generally mechanically connected to the frame of the machine or to nearby fixed element (by means for example of hinges or guides), and that can be opened without the use of tools.	MG
INTERLOCKED MOBILE GUARD	Guard associated with an interlock device so that: The machine's dangerous functions «protected» by the guard cannot be carried out unless the guard has been closed – If the guard is opened during the unfolding of the machine's dangerous functions, a stop command is given – The closure of the guard permits execution of the machine's dangerous functions «protected» by the guard but it does not control the start up.	IMG
SAFETY DEVICE	(other than a guard) that eliminates or reduces the risk, either alone or in association with a guard	SD
INTERLOCK DEVICE (INTERBLOCK)	A mechanical or electrical or other kind of device whose aim is to prevent elements of the machine from functioning under specified conditions (generally until the guard is closed).	ID
PROTECTION STRUCTURE	A physical obstacle such as a guard or part of the machine, that limits the movement of the body and/or one of its parts. The safety distances have been determined on the basis of the requisites at point 4.1.1 of the standard UNI EN294.	
SAFETY DISTANCE	The minimum distance a protective structure must be positioned with respect to a dangerous area. The safety distances have been determined on the basis of the requisites at point 4.1.1 of the standard UNI EN294.	
INDIVIDUAL PROTECTION DEVICE	Safety devices such as gloves, shoes, helmet, visor, earplugs etc. aimed at protecting parts of the body.	IPD
CONTROL CIRCUIT	A circuit used to control the working of the machine and protect the power circuits.	
CONTROL DEVICE	A device inserted into a control circuit and used to control the	

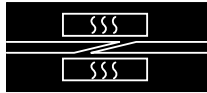

Author: A.T.
Edition: 09/2004
Replaces:

REGULATIONS AND GENERAL WARNING NOTES

Page **A-9**

TERM	DEFINITION	ABBREV.
	working of the machine (e.g. position sensors, manual control switches, relays and electromagnetic valves).	

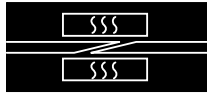

Author: A.T.
 Edition: 09/2004
 Replaces:

REGULATIONS AND GENERAL WARNING NOTES
 Page **A-10**

SECTION A.6 SAFETY WARNINGS

When using industrial machines and systems, one should be aware that moving mechanical parts (linear or rotary movement), high voltage electrical parts, and any parts at high temperature, etc, can cause serious damage to people and things.



In designing and building the machine, the Manufacturer focused special attention on safety in order to supply a SAFE machine and, therefore, the Manufacturer has provided protective and safety devices considered necessary according to the Risk Analysis carried out by expert personnel. People in charge of system safety must make sure that the following essential safety regulations are observed:

	Do not run the machine with the fixed and mobile protective devices dismantled or disabled.
	Do not run the machine with the fixed and mobile protective devices dismantled or disabled. It is forbidden to switch off safety devices installed on the machine or create by-pass systems to limit switches or micro-switches.
	Operations with reduced safety devices must be carried out while observing to the letter the instructions in the relevant descriptions, and must be performed by specialized technicians aware of the risk, under the direct supervision of the company person responsible for safety; active protective devices must be restored as soon as possible, limiting this high-risk status to the minimum.
OFF	Cleaning and maintenance operations must be performed with the electrical and pneumatic cutout devices switched OFF. To this end, the machine is provided with emergency push-buttons which shut down the system. It is good practice to use them as safety lockouts to avoid accidental starting during inspections or mechanical jobs.
	Clean the machine covers and the control panel with soft, dry cloths lightly dampened in detergent; do not use solvents as they could damage the surfaces.
	Do not modify the machine or its parts; otherwise, the Manufacturer shall not hold itself responsible for damage to persons and things. Request any modifications/customizing directly from the Manufacturer

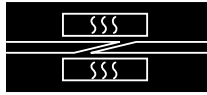

Author: A.T.
Edition: 09/2004
Replaces:

REGULATIONS AND GENERAL WARNING NOTES

Page **A-11**

SECTION A.7 REMAINING RISKS

The use of the machine during its operation may give risk to additional risks such as the following:

The possibility of crushing occurring during press closing

The possibility of burns occurring in the pressing area if the temperature is not first checked or if suitably protective gloves are not worn.

The possibility of scalding or burning occurring by hot liquid or steam in the cooling circuit if the cooling cycle is incorrectly stopped without paying attention to the warnings given in this manual

The possibility contact between water and live equipment.

The user is responsible for taking care during transportation and movement of the equipment where the use of extraneous equipment (such as forklift trucks etc.) present dangers from bumping into and crushing persons in the area of these operations.

Ensure during equipping and maintenance operations that the stages in the chapters of the manual are scrupulously adhered to and have these operations carried out only by suitably prepared and qualified persons.

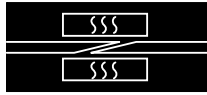



Author: A.T.
 Edition: 09/2004
 Replaces:

REGULATIONS AND GENERAL WARNING NOTES
 Page **A-12**

SECTION A.8 QUALIFICATIONS OF PERSONNEL

Each task must be assigned to a person trained in the work to be carried out and trained in correct usage as well as fully aware of any remaining risks and dangers in that work. Personnel must not carry out work outside their area of competence, knowledge and responsibility.

TABLE 4 - QUALIFICATIONS

	<p>FIRST LEVEL MACHINE CONTROL OPERATOR</p> <p>Indicates non qualified personnel i.e. without specific competencies and able only to carry out simple tasks, including in practice running the machine with the use of the controls on the push-button panel and loading and unloading materials used during production. Furthermore, this operator can work with the machine while the machine's protective devices are enabled, to carry out simple, ordinary jobs for adjusting, starting or re-starting production following enforced downtime.</p>
	<p>MECHANICAL MAINTENANCE PERSON</p> <p>A qualified technician able to run the machine under normal conditions, to intervene on mechanical parts to make all adjustments as well as the necessary mechanical maintenance and repair jobs, also with the protective devices disabled.</p>
	<p>ELECTRICAL MAINTENANCE PERSON</p> <p>A qualified technician able to run the machine under normal conditions, and also with the protective devices disabled; s/he is entrusted with all electrical jobs involving adjustment, maintenance and repairs. This operator is able to work while the interior of the cabinets and the connector blocks are electrically live.</p>
	<p>QUALIFIED TECHNICIAN</p> <p>A person who is by training, experience, education and knowledge of accident prevention regulations and procedures able to perceive and avoid possible dangers and who is authorized by the plant's safety officer to carry out all necessary mechanical and electrical intervention.</p>
	<p>SPECIALIZED SUPERVISOR</p> <p>An expert, specialized technician provided by the Manufacturer to carry out complex operations in particular situations, installation, first start-up, instruction of the Customer's personnel, as well as overhauls of and modifications to the machine.</p>

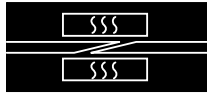

SECTION A.9 REFERENCES AND STANDARDS

Section. A.9.1 APPLICABLE EU DIRECTIVES

EU Directive N° 98/37 of 23.07.98 known as the "Machines directive".
EU Directive N° 60/204 known as "Low tension directive"
EU Directive N° 89/336 for the convergence of Member State law on electromagnetic compatibility.

Application of the above directives is formalized through the signing of the MANUFACTURER'S DECLARATION OF CONFORMITY drawn up once the inspection test has been carried out at the place of installation.

This machine has been constructed in a country that is part of the European Community and therefore meets the safety requirements of EU directive 98/37/CE, in force from 23 July 1998.

This conformity is certified and the machine bears the CE mark of compliance. (See figure)

Section. A.9.2 EU DIRECTIVES CONCERNING SAFETY IN THE WORKPLACE

EU Directive N° 89/391 concerning the improvement of the safety and health of workers during work, in addition to the following particular directives EU N° 89/654 and N° 89/655.
EU Directives N° 77/576 and N° 79/640 concerning safety signs in the workplace.

Section. A.9.3 EU DIRECTIVES CONCERNING PERSONAL PROTECTION

EU Directive N° 89/656 and N° 89/686 concerning the use of personal protection devices.

Section. A.9.4 COMMUNITY DIRECTIVES ON THE PROTECTION OF THE ENVIRONMENT

EU Directives N° 75/442 on the disposal of waste.
EU Directives N° 78/319 on the disposal of toxic and harmful waste.

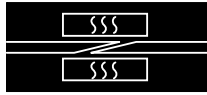

SECTION B - TECHNICAL SPECIFICATIONS

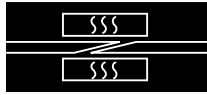

Author: A.T.
Edition: 09/2004
Replaces:

TECHNICAL SPECIFICATIONS
Page **B-2**

SECTION B.1 PURPOSE OF THE MACHINE

The hot press PM-1056/160 has been specifically developed for hot joining of HABASIT of drive and conveyor parts using the Thermofix and Flexproof process.

The Thermofix process includes all the flat belts and other Habasit conveyor belts with right-angled or oblique-angled joins (for width and thickness details see: [TECHNICAL CHARACTERISTICS OF THE PRESS.](#))

The Flexproof process includes most of the Food and Standard conveyor belts from Habasit as well as the thermoplastic transmission belts (for width and thickness see: [TECHNICAL CHARACTERISTICS OF THE PRESS.](#))

Further details about these processes can be obtained at:

For the **Thermofix** process (Manual 3210).

For the **Flexproof** process (Manual 3220 or 3225).

NOTE

By connecting to the company IT net H/Net it is possible to access updated processes using the developments brought to them. The hot press PM-1056/160 has been developed exclusively for the applications described herein. No other or inappropriate applications are permitted.

ATTENTION

ANY USE OF THE MACHINE OTHER THAN FOR WHICH IT WAS DESIGNED MAY BE IMPROPER USE AND RESULT IN NOT BEING SAFE FROM THE POINTS OF VIEW OF THE OPERATOR, MAINTENANCE WORKER AND OF THE MACHINE ITSELF. HABASIT SHALL NOT BE HELD LIABLE FOR THE CONSEQUENCES OF ANY BREACHES OF THESE RULES

IMPORTANT

All assembly, maintenance and repair work, as well as the operation of the equipment, is expected to be carried out by qualified personnel or staff under the supervision of responsible specialists and experts.

In case of doubt or lack of detailed information, always contact the manufacturer see [HOW THE MANUAL IS ORGANIZED](#)

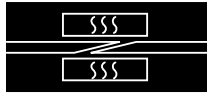

Author: A.T.
Edition: 09/2004
Replaces:

TECHNICAL SPECIFICATIONS
Page **B-3**

SECTION B.2 PRESS IDENTIFICATION DATA

A plate fitted to the structure of the machine indicates the machine's identification data. These data are shown in the following figure.

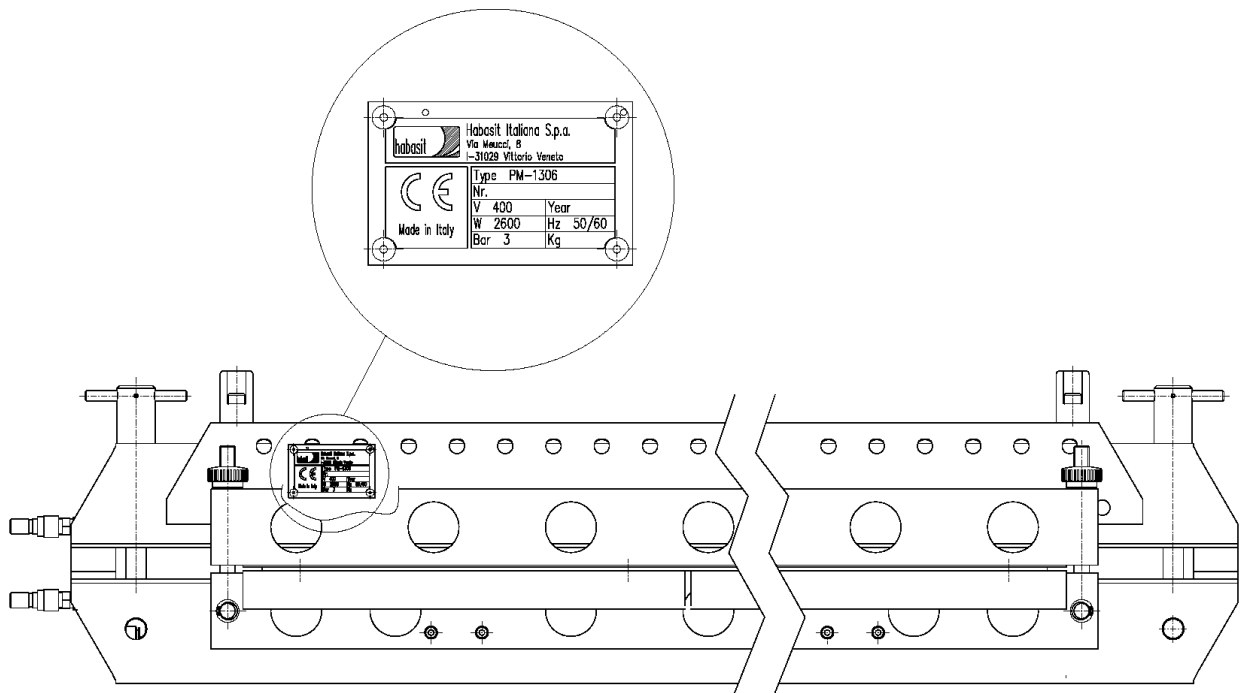
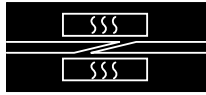

FIGURE 1 - MACHINE IDENTIFICATION PLATE



Author: A.T.
Edition: 09/2004
Replaces:

TECHNICAL SPECIFICATIONS

Page **B-4**

SECTION B.3 TECHNICAL CHARACTERISTICS OF THE PRESS

TABLE 5 - ELECTRICAL CHARACTERISTICS OF HEATING ELEMENTS

Output	4 x 1370 W = 5480 W
Supply tension	230V~
Frequency	50-60 Hz

TABLE 6 - PNEUMATIC CHARACTERISTICS

Fluid characteristics	Filtered, non-lubricated air
Working pressure	6 bars +/- 0.2 bars
Min. supply diameter	Rapid connector of 1/4"

TABLE 7 - WATER CHARACTERISTICS

Fluid characteristics	Demineralized water
Capacity	5 m ³ /h (*)
Working temperature	From 10 ° to 35 °
Min. supply diameter	Rapid connector of 1/4"

(*) mobile pump capacity

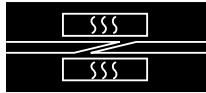

Author: A.T.
 Edition: 09/2004
 Replaces:

TECHNICAL SPECIFICATIONS

Page **B-5**

TABLE 8 - DIMENSIONS AND ENVIRONMENTAL CHARACTERISTICS

Dimensions (LengthxWidthxHeight) (including handles)	1400+250x380x288 mm 55+10 x 14.9 x 11.3 in
Total Weight	117 kg / 258 lbs.
Upper part weight	43 kg / 94.8 lbs.
Lower part weight	40.5 kg / 89.3 lbs.
Steel stabilizers weight	33.2 kg / 73.2 lbs.
Noise level	<70 db
Working temperature	Between 15°C – 38°C
Humidity tolerance	Between 45 – 70%

TABLE 9 - CHARACTERISTICS OF WORKABLE ELEMENTS

Max length of belt	1050 mm / 41.3 in
Max width of belt	10 mm / 0.4 in
Minimum length of belt	940 mm / 37 in
Heating plate width	160 mm / 6.3 in
Maximum presser pressure	3 bar / 43.5 psi **
Max. working temperature	199°C / 390°F
Temperature interval	+ 2°/- 4°C + 3.6° / - 7.2°F
Maximum heating plate temperature deviation from nominal value	+/- 2°C/3.6°F
Mean heating time at 180°C	15 min. (230V~) 20 min. (400V~)
Cooling time from 180°C to 80°C (with room temperature water)	3 min.

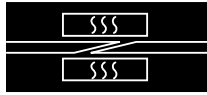

Author: A.T.
 Edition: 09/2004
 Replaces:

TECHNICAL SPECIFICATIONS
 Page **B-6**

SECTION B.4 EQUIPMENT AND ACCESSORIES PROVIDED

The following are the necessary accessories for fixed and mobile use

Section. B.4.1 NECESSARY ACCESSORIES FOR FIXED USE

TABLE 10 - NECESSARY ACCESSORIES FOR FIXED USE

Code	Description	Qty.	PM-1056/160 230V	PM-1056/160 400V
692070	PRESS PM-1056/160 230V		X	X
	PRESS INSTRUCTION MANUAL PM (SERIE 6) (PM-xx06)	1	X	X
691011	CABLE CONNECTION PAIR REGULATOR PMR-04/PMR-06 AND OUTLET PM.	1	X	X
20501000	MATERIAL PROVIDED	1	X	X
	PLASTIC TUBE PVC 6x12 cod. TA06	5 mt.		
	TUBE CLAMP 14x24 MINUSSGM	12		
	COLLAR WITH TWO EARS COL-PI 11x13	3		
	FEMALE COUPLING 1/4" cod. 403 1/4SV (RAPID FIT)	4		
	HOSE-END FITTING 12x1/4" CH 17	4		
	HOSE-END FITTING 6x1/4" Code1.13234	1		
	MANITOBA TUBE D.10x21mm 170° L=20ml	1		
	COPPER WASHER 1/4"	4		
	FEMALE COUPLING 04 MINI 1/4" cod.01010004	1		
	REGULATING UNIT PMR-XX The regulating unit varies according to working tension. The regulating unit is thus determined by the working tension of the press it is combined with	1		
691023	PMR-06 1x230V			
691020	PMR-06 3x230V		X	
691021	PMR-06 3x400V			X
	UNITÀ DI REGOLAZIONE PMC-XX (L'unità di controllo può variare a seconda dell'unità di regolazione PMR-XX utilizzata)	1		
691060	PMC-06 1x230V		X	X

For the selection of regulating unit PMR-XX and control unit PMC-XX see [Section. B.4.3 Regulating unit options](#). For the selection of control unit PMC-XX see [Section. B.4.4 Control unit options](#)

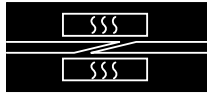

Author: A.T.
 Edition: 09/2004
 Replaces:

Section. B.4.2 NECESSARY ACCESSORIES FOR MOBILE USE

The following are indications for the necessary accessories for mobile use.

TABLE 11 - ACCESSORIES NECESSARY FOR MOBILE USE

Code	Description	Qty.	PM-1056/160 230V	PM-1056/160 400V
692070	PRESS PM-1056/160 230V		X	X
	PRESS INSTRUCTION MANUAL PM (SERIE 6) (PM-xx06)	1	X	X
691011	CABLE CONNECTION PAIR REGULATOR PMR-04/PMR-06 AND OUTLET PM.	1	X	X
	REGULATING UNIT PMR-XX. The regulating unit varies according to working tension. The regulating unit is thus determined by the working tension of the press it is combined with	1		
691023	PMR-06 3x130V			
691020	PMR-06 3x230V		X	
691021	PMR-06 3x400V			X
	MOBILE COOLING UNIT. The control unit varies according to the available electrical power.	1		
691016	MOBILE COOLING UNIT PM-4/7 230V			X
691015	MOBILE COOLING UNIT 120V		X	
	MOBILE MINI COMPRESSOR The control unit may vary according to the electrical tension available	1		
691017	MOBILE MINI COMPRESSOR PM-4/7 230V			X
691018	MOBILE MINI COMPRESSOR 120V		X	

For selection of the regulating unit PMR-XX see [Section. B.4.3 Regulating unit options.](#)

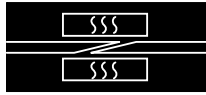

Author: A.T.
 Edition: 09/2004
 Replaces:

TECHNICAL SPECIFICATIONS

Page **B-8**

Section. B.4.3 REGULATING UNIT OPTIONS

The following are indications of the combinations of possible use between joining presses and PMR-XX regulating units.

TABLE 12 - REGULATING UNIT OPTIONS (PMR-XX) (PRESS-XX COMBINATIONS)

Codice	691301	691302	691306	691307	691023	691020	691021
	PMR-305 1x120V 360W	PMR-305 1x230V 400W	PMR-305 RC06 1x120V 3600W	PMR-305 RC06 1x230V 3600W	PMR-06 1x230V	PMR-06 3x230V	PMR-06 3x400V
PM-305	X	X					
PM-306			X	X	X	X	X
PM-606			X	X	X	X	X
PM-806				X	X	X	X
PM-806/160					X	X	X
PM-1056				X	X	X	X
PM-1056/160					X	X	X
PM-1306					X	X	X
PM-1306/160						X	X
PM-1606						X	X
PM-2006						X	X
PM-804				X	X	X	X
PM-1604						X	X
PM-2404						X	X
PM-3204						X	X
PM-3604						X	X
PM-4204						X	X

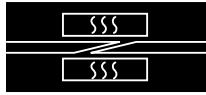

Author: A.T.
 Edition: 09/2004
 Replaces:

TECHNICAL SPECIFICATIONS

Page **B-9**

Section. B.4.4 CONTROL UNIT OPTIONS

The following are indications of the combinations of possible use between PMC-XX control units and regulating units PMR-XX.

TABLE 13 - CONTROL UNIT OPTIONS (PMC-XX) (PMR-XX – PMC-XX COMBINATIONS)

	PMR-04	PMR-06	Code
PMC-04 (1x230V)	X	X	691010
PMC-06		X	691060

Section. B.4.5 OPTIONAL ACCESSORIES FOR BOTH FIXED AND MOBILE USE

The following are indications for the optional accessories both for fixed or variable use situations.

TABLE 14 - OPTIONAL ACCESSORIES (FOR BOTH FIXED AND MOBILE USE)

Description	Code
Pair of gloves	N-29090
Thermometer	N-28714 or N-28715
Sizing press film roll with matt silicone layer	N-28638
Sizing press film roll with structured silicone layer	N-28637
Various sizing films, ask our specialists	
Molleton type felt coil	N-28665

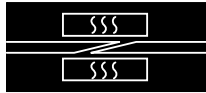

Author: A.T.
Edition: 09/2004
Replaces:

TECHNICAL SPECIFICATIONS
Page **B-10**

SECTION B.5 ORDERING ACCESSORIES/SPARE PARTS

IMPORTANT

To order accessories or spare parts, please do the following:

Quote the name of the machine
Quote the position of the piece
Quote the description of the piece
Quote the technical code

When making your request, briefly illustrate the causes of failure of the part being ordered, and provide all information which may be useful for understanding the malfunction; this will make it possible to pinpoint any shortcomings or incorrect procedures which may have caused the damage.

When ordering spare parts, we recommend using the fax and not just placing your order by phone.

Habasit Italiana S.p.A.
Via A. Meucci 8
Zona Industriale
I - 31029 Vittorio Veneto
Tel.: 0039. (0) 438.9113
Fax: 0039.438.200545

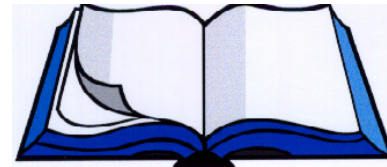

The parts marked P and N are available at the parent company of Habasit Reinach, Switzerland.

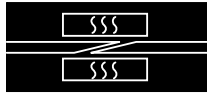

SECTION C - INSTALLATION

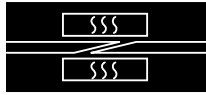

Author: A.T.
Edition: 09/2004
Replaces:

INSTALLATION
Page C-2

SECTION C.1 PREPARATION OF WORK SITE

ATTENTION

The press must be placed on a floor or support of suitable size that is able to take the weight and bulk of the equipment.

The machinery must be placed in a room with sufficient lighting, avoiding dazzling and stroboscopic effects. Personnel entrusted to control the machine must be able to work under normal light conditions (usually provided by neon lights fitted on the ceiling). If the lighting level is insufficient, the Customer must provide an additional lighting system since the machinery is not supplied with its own lighting system for the operational zone.

The work area must be well ventilated and/or have an air cycling and emission system compliant with the law of the country of installation, such as to ensure the operator is working under the proper working conditions.

The free space around the machine must be sufficient for work and maintenance operations and permit access all workstations taking account of the size of the pieces to be worked on.

The Customer must provide all the sources of energy required for electrical power and compressed air as indicated in [TECHNICAL CHARACTERISTICS OF THE PRESS](#)

Ensure there is sufficient operational space around the press.

Make sure that there is a properly stocked first aid box on site nearby.

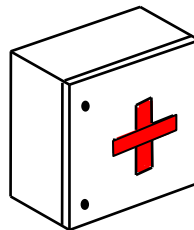

ATTENTION

The main switch M.S. of the electrical panel must be in its «OFF» position when the machine is being connected up.

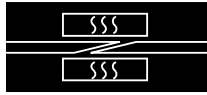

Author: A.T.
Edition: 09/2004
Replaces:

INSTALLATION
Page C-3

SECTION C.2 PACKING AND HANDLING

Section. C.2.1 FIRST DELIVERY / FIXED OPERATION USE

ATTENTION

The movement of the packaging and machinery should be carried out by authorized operators.

Suitable equipment must be used to move the machinery, with adequate strength to deal with the weight and bulk of the press.

When unpacking, check that no small parts remain in the case, and carefully check the general conditions.

In transit, or on being moved, the press must be disconnected from any control or regulating units.

There are two handles at the side of the press for lifting the equipment (3). The fastening rods at each end of the press must be evenly locked before hoisting.

Never use any hooking points other than the specific (3) eyebolts when hoisting the press.

The fastening rods (4) must be correctly closed

IMPORTANT

REPORT ANY DAMAGE NOTED ON THE MACHINE AT DELIVERY TO THE CARRIER AND SUPPLIER.

Packing materials (wood, nails, plastic, barrier bags, etc.) can be sources of danger and should be placed in collection points, especially if polluted or non-biodegradable.

The user must observe the waste disposal legislation in the country of installation when disposing of the packaging.

ATTENTION

ALL HANDLING OPERATIONS OF THE PRESS MUST BE PERFORMED SLOWLY WITHOUT ANY SUDDEN MOVEMENTS, TO AVOID DAMAGING PERSONS AND THINGS.

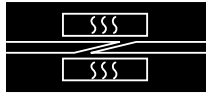

Section. C.2.2 MOBILE OPERATION HANDLING

To make transportation of the press easier it can be dismantled as indicated:

If connected, disconnect the various electrical, water and air connections in order
Disassemble the upper part of the press (1) (the support with the heating element)
Disassemble the lower part of the press (6) (the support with heating element)
Disassemble the sheet steel heat stabilizer with locking device (8)
Use suitable handling and transport equipment capable of dealing with the object's weight, while taking care during the transportation itself.
Reassemble the press and ensure that its mechanical parts are functioning properly
Reconnect the power while taking when handling electrical power sources close to the water used in the cooling system.

The press can also be moved as a single unit, in which case the following must be carried out:

If connected, disconnect the various electrical, water and air connections in order
Use transportation equipment of the correct capacity for the weight of the object to be moved
Verify that the press and all its mechanical parts have not been damaged in transit and that all are working correctly
Reconnect the power while taking when handling electrical power sources close to the water used in the cooling system.

ATTENTION

ALL OPERATIONS MUST BE PERFORMED BY PROPERLY TRAINED AND EXPERT PERSONNEL.

ATTENTION

ALL HANDLING OPERATIONS OF THE PRESS MUST BE PERFORMED SLOWLY WITHOUT ANY SUDDEN MOVEMENTS, TO AVOID DAMAGING PERSONS AND THINGS.

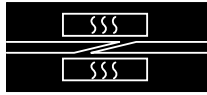

SECTION C.3 ASSEMBLING AND INSTALLATION

Preliminary check

Carry out a visual check on the press' appearance and on any accompanying equipment to see if there are signs of damage or breakage that may have occurred in transit. If such damage and/or failures are noted, contact HABASIT immediately. We advise you to also produce photographic evidence of the damage.

Section. C.3.1 POSITIONING

IMPORTANT

This operation requires the involvement of a **QUALIFIED TECHNICIAN** able to carry out and check correct positioning in observance of current safety regulations:

Make sure there is sufficient operational space for working on the press
Position the press so that it is stable
Check visually to make sure that no rags, work tools, etc remain on the press.

Section. C.3.2 CONNECTION OF AIR AND WATER SUPPLIES

ATTENTION

The press can be used in fixed operation mode (permanently connected to control and regulation equipment) or in Mobile operation (when it is necessary to carry out work away from the usual site).

Fixed operation

Ensure that the whole system is not supplied by electrical, air and water sources
Ensure all the plant preceding the equipment corresponds with its own specifications
Using the pneumatic connection kit (code 008E1000), connect the presser cushions of the upper and lower sides.

The water and air power sources' output is handled by the control unit **PMC-XX**. Referring to [Section. B.4.4 Control unit options](#) ensure the control unit is suited to the press and regulating unit actually in use.

Make the necessary water connections between the control unit **PMC-XX** and the joining press

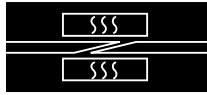

Author: A.T.
Edition: 09/2004
Replaces:

INSTALLATION
Page **C-6**

Make the necessary water and air connections between the water supply and the control unit **PMC-XX**

Ensure the water connections are well sealed and that any leaks that could occur do not come into contact with electrical parts

Mobile operation

Running the system in its mobile operation requires the use of suitable instruments (such as a portable compressor for the air supply and a water tank with immersion pump or available running water).

Ensure that the whole system is not supplied by electrical, air and water sources

Ensure all the plant preceding the equipment corresponds with its own specifications

Using the pneumatic connection kit (code 008E1000), connect the presser cushions of the upper and lower sides.

Ensure the water connections are well sealed and that any leaks that could occur do not come into contact with electrical parts

Section. C.3.3 ELECTRICAL CONNECTION

ATTENTION

Ensure that the whole system is not supplied by electrical, air and water sources
Ensure all the plant preceding the equipment corresponds with its own specifications
The electrical power parts (and water and air supply logic systems) are managed by the regulating unit **PMR-XX**. Referring to [Section. B.4.3 Regulating unit options](#) ensure the regulating unit is suitable for the press actually in use.

Connect the press's connectors to the regulating unit **PMR-XX**

If present carry out the necessary connections between the regulating unit **PMR-XX** and the control unit **PMC-XX**.

Connect the regulating unit **PMR-XX** to the mains electrical supply (see manual **PMR-XX**)

NOTE

The use of the regulating unit is necessary both for fixed operation and for mobile operation.

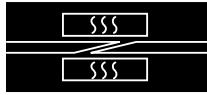

SECTION C.4 DISASSEMBLY OF THE MACHINE

Machine dismantling operations must be performed by:

Technicians of HABASIT Assistance Service.

Technicians authorized by HABASIT, with experience of: Machine assembly/disassembly
Assembly/disassembly of the electrical, pneumatic and hydraulic plant, consulting the
corresponding diagrams.

ATTENTION

BEFORE CARRYING OUT ANY KIND OF WORK ON THE MACHINE IT IS ESSENTIAL TO ENSURE THAT THE PLANT (ELECTRICAL, PNEUMATIC AND WATER) IS DISCONNECTED FROM ENERGY SUPPLIES, THAT THE PNEUMATIC AND WATER PLANT IS PROPERLY DEPRESSURISED AND THAT THERE IS NO REMAINING POTENTIAL ENERGY IN THE MOVING PARTS

ATTENTION

Follow the following disconnection procedure:

Disconnect the electrical circuit.

Disconnect the water circuit

Disconnect the air circuit

Carry out mechanical disassembly

If the machine has to be stored for a certain time, prepare it as indicated in the next section, but if it has to be handled immediately, refer to the appropriate section.

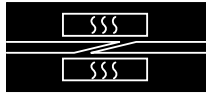

Author: A.T.
Edition: 09/2004
Replaces:

INSTALLATION
Page C-8

SECTION C.5 STORAGE

IMPORTANT

The machine must be stored in a dry room free from seepage of liquids.

NOTE

Never, on any account, store the machine out of doors! As a general rule, observe the following environmental conditions.

TABLE 15 - STORAGE CONDITIONS

	Environmental conditions for storage
Min/Max ambient temperature for storage	In range +5 °C to +40 °C
Relative humidity of place of storage	In range 50% to 70%

If the machine, its accessories and spares have to remain in storage for a prolonged period, they must be protected from dust and damp.

We recommend the following:

Clean the machine in general

Apply PROTECTIVE SILICONE OIL to UN-painted or UN-treated parts.

Cover the machine with a sheet to protect it from dust.

Before being oiled or greased for good preservation, some parts can, if necessary, be cleaned with a specific, rustproofing detergent.

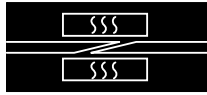

SECTION C.6 DISPOSAL

IMPORTANT

The press PM-1056 is built with different types of material. When they have reached the end of their useful life, such materials must be disposed of at the specialized centers, according to the prescriptions of the laws in force in the country of destination.

ATTENTION

The materials and substances making up the machine **MUST** be eliminated according to the Laws/Regulations on disposal of individual waste in force in the country where the machine is installed.

IN ANY EVENT, NO COMPONENT OF THE MACHINE MUST BE LEFT IN THE ENVIRONMENT.
CONTACT AN AUTHORIZED COMPANY TO CARRY OUT THIS TYPE OF OPERATION.

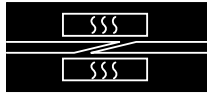

SECTION D - OPERATION

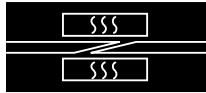

Author: A.T.
Edition: 09/2004
Replaces:

OPERATION
Page **D-2**

SECTION D.1 GENERAL WARNINGS

The operator and/or the maintenance person has the following responsibilities:

To create on and around the press the necessary conditions so that the installed protective devices are operational and efficient, as their purpose is to protect the personnel.

To observe the safety regulations described in the use and maintenance manual.

IMPORTANT

THE INFORMATION DEVICES (SIGNS) AND SAFETY NOTICES AFFIXED TO THE MACHINE MUST BE KEPT CLEAN AND LEGIBLE.

ATTENTION

DO NOT IN ANY WAY ALTER THE MACHINE'S SAFETY SYSTEM.

ATTENTION

IT IS ABSOLUTELY FORBIDDEN TO REMOVE THE PROTECTIVE DEVICES INSTALLED ON THE MACHINE.

ATTENTION

CARRYING OUT CLEANING AND MAINTENANCE JOBS WHILE THE SYSTEMS ARE LIVE OR UNDER PRESSURE IS ABSOLUTELY FORBIDDEN.

ATTENTION

DO NOT REMOVE THE GUARDS WHICH REQUIRE TOOLS FOR THEIR REMOVAL.

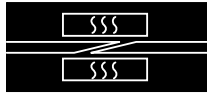

Author: A.T.
Edition: 09/2004
Replaces:

OPERATION
Page **D-3**

SECTION D.2 GUARDS INSTALLED

IMPORTANT

The press has a sheet steel guard with holes to prevent the operator coming into contact with hot parts.

ATTENTION

READ THE ACCIDENT PREVENTION SIGNS (APS) ON THE MACHINE WITH CARE, DO NOT COVER THEM FOR ANY REASON AND REPLACE THEM IMMEDIATELY IF THEY GET DAMAGED

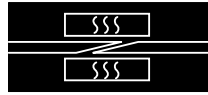

Author: A.T.
Edition: 09/2004
Replaces:

OPERATION
Page D-5

SECTION D.3 PRESS PARTS IDENTIFICATION

Section. D.3.1 VIEW OF PM-1056/160

- 1) Upper part of the press.
- 2) Air connection point for pressure cushion.
- 3) Eye bolt (for hoisting).
- 4) Fastening rod.
- 5) Water fitting.
- 6) Lower part of the press.
- 7) Heating plate.
- 8) Steel heat stabilizers with locking device.

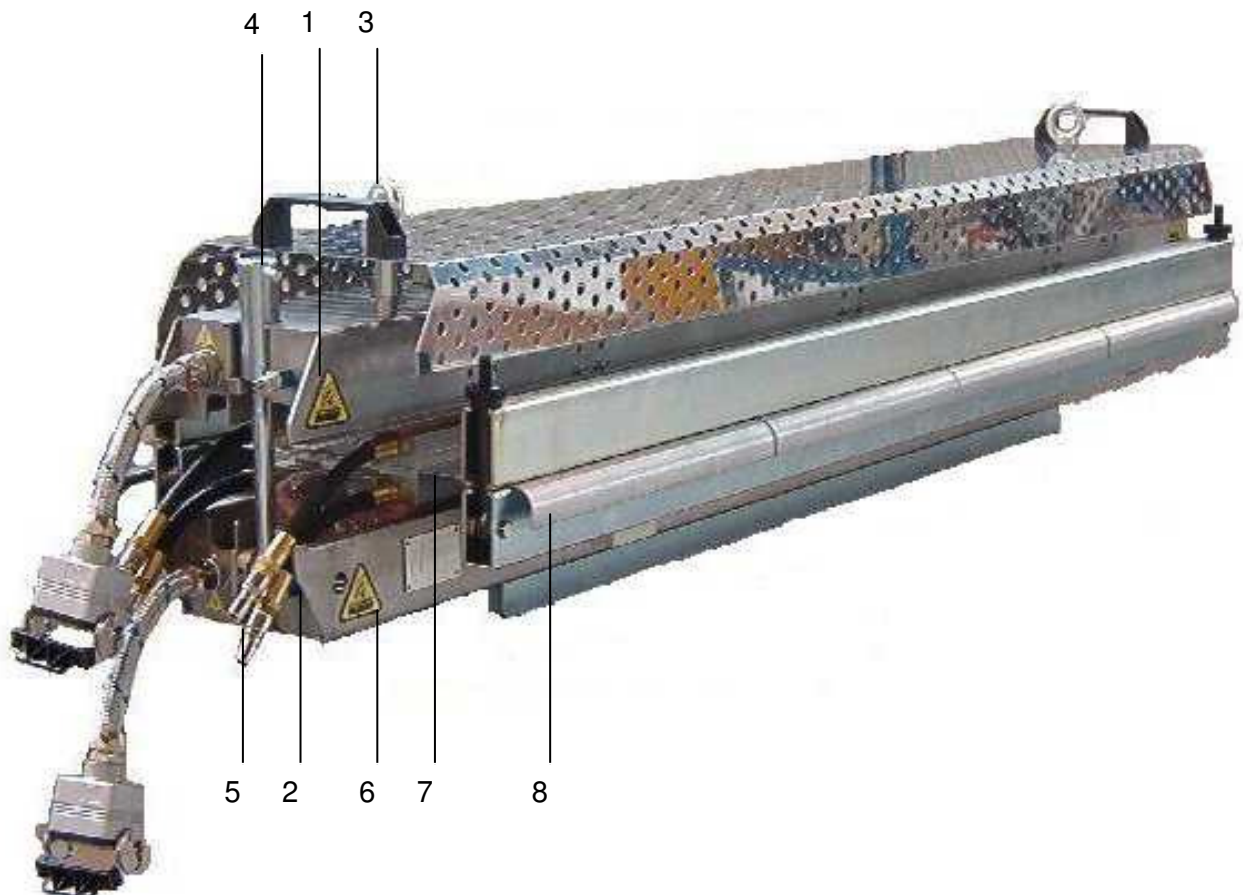
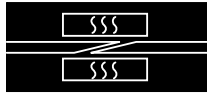

FIGURE 3 - VIEW OF PM 1056/160



Section. D.3.2 MAIN ELEMENTS OF THE PM-1056/160

- 1) Upper part of the press.
- 2) Fastening rod.
- 3) Lower part of the press.
- 4) Heating plate.
- 5) Heat stabilizers with locking device.

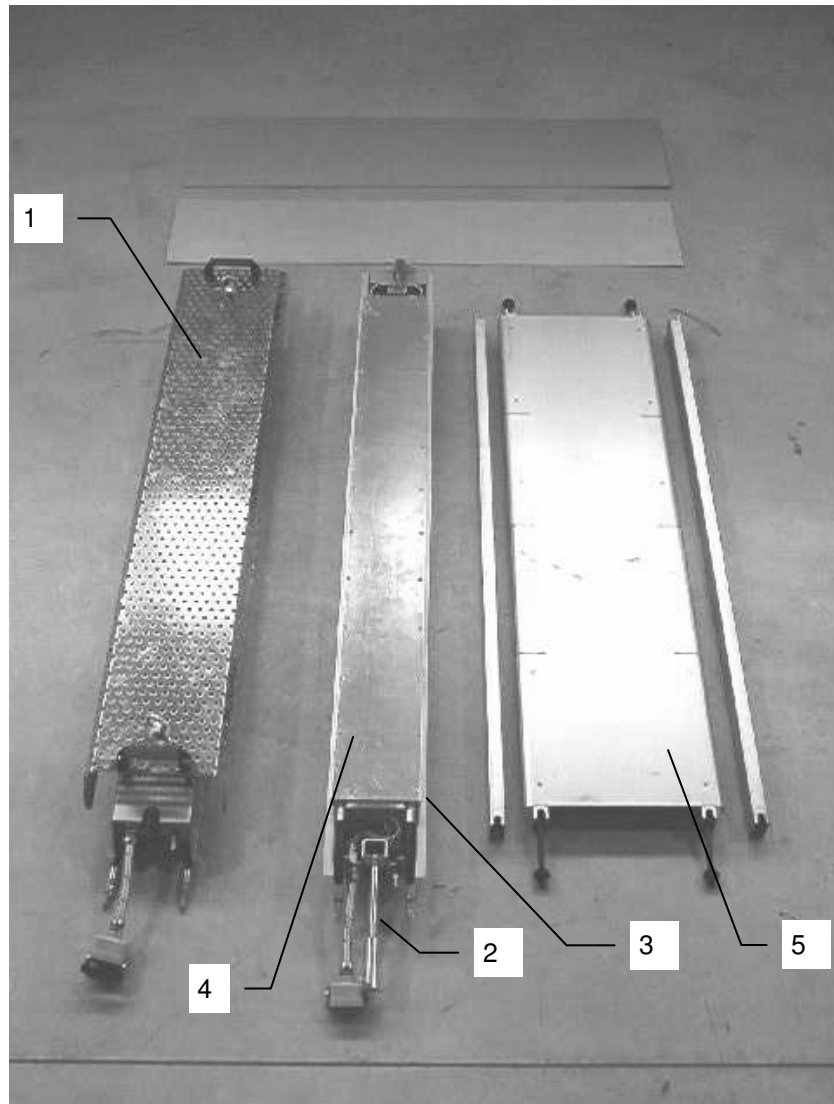
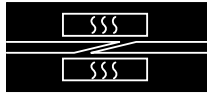

FIGURE 4 - MAIN ELEMENTS OF THE PM 1056/160



Author: A.T.
Edition: 09/2004
Replaces:

OPERATION
Page D-7

Section. D.3.3 COMPRESSED AIR CONNECTIONS



FIGURE 5 - COMPRESSED AIR CONNECTIONS

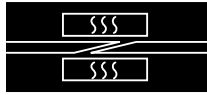

Author: A.T.
 Edition: 09/2004
 Replaces:

OPERATION
 Page D-8

SECTION D.4 MACHINE CONFIGURATION

The following are the possible configurations for fixed operation and variable operation.

Section. D.4.1 FIXED OPERATION USE

Fixed operation use with PMR-06 and PMC-04

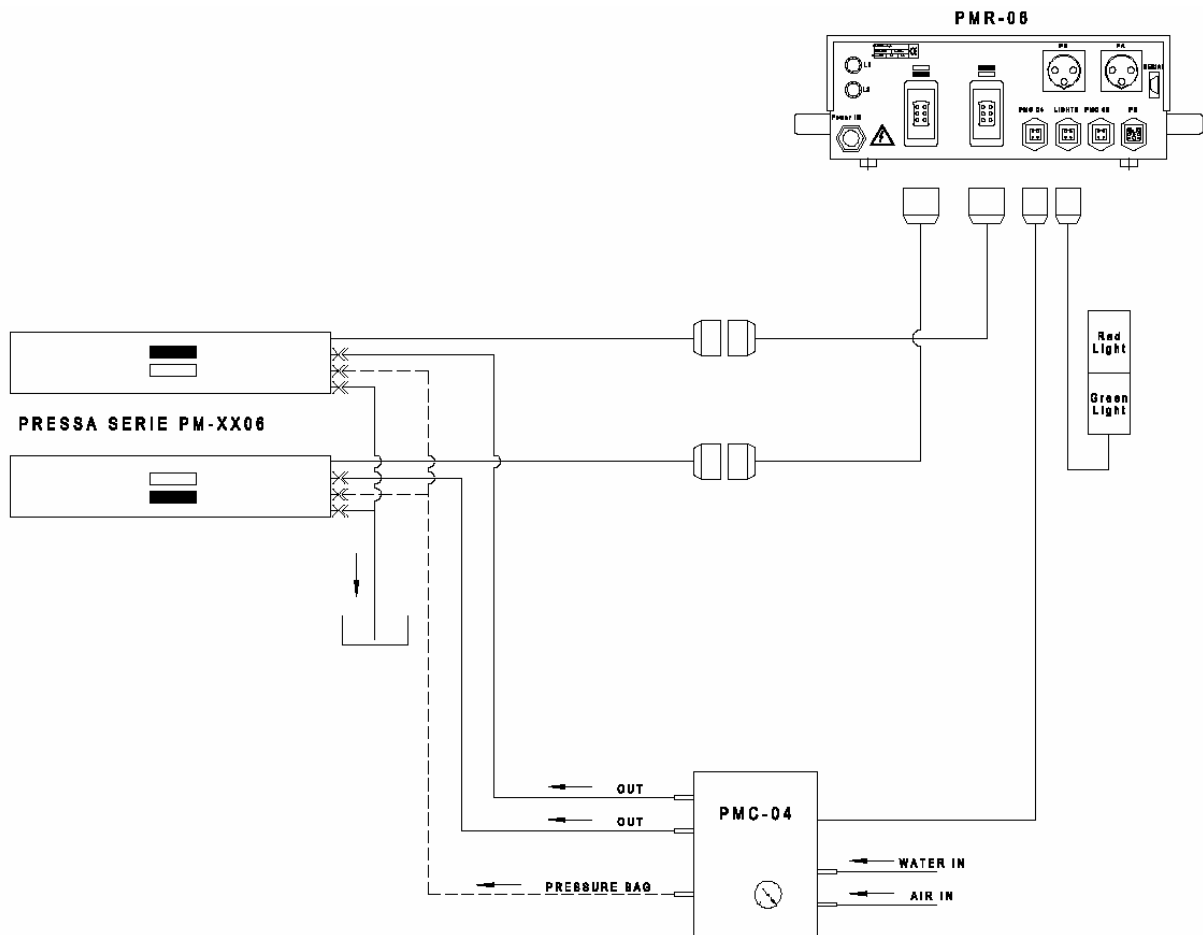
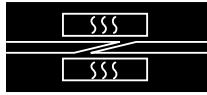

FIGURE 6 - FIXED OPERATION USE WITH PMR-06 AND PMC-04



Author: A.T.
Edition: 09/2004
Replaces:

OPERATION
Page D-9

Fixed operation use with PMR-06 and PMC-06

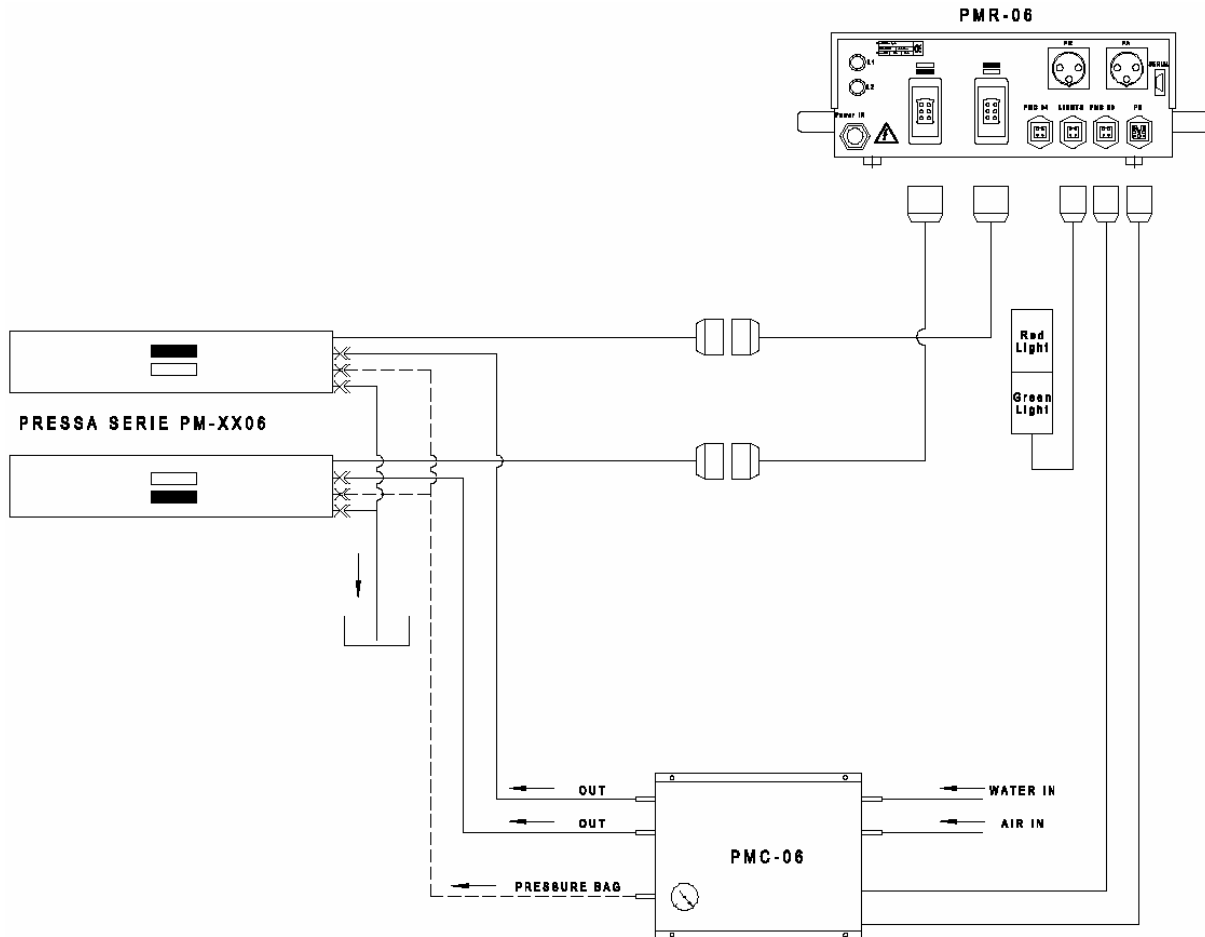
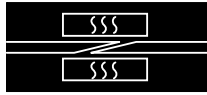

FIGURE 7 - FIXED OPERATION USE WITH PMR-06 AND PMC-06



Author: A.T.
Edition: 09/2004
Replaces:

OPERATION
Page D-10

Section. D.4.2 MOBILE OPERATION USE

Mobile operation use with PMR-06

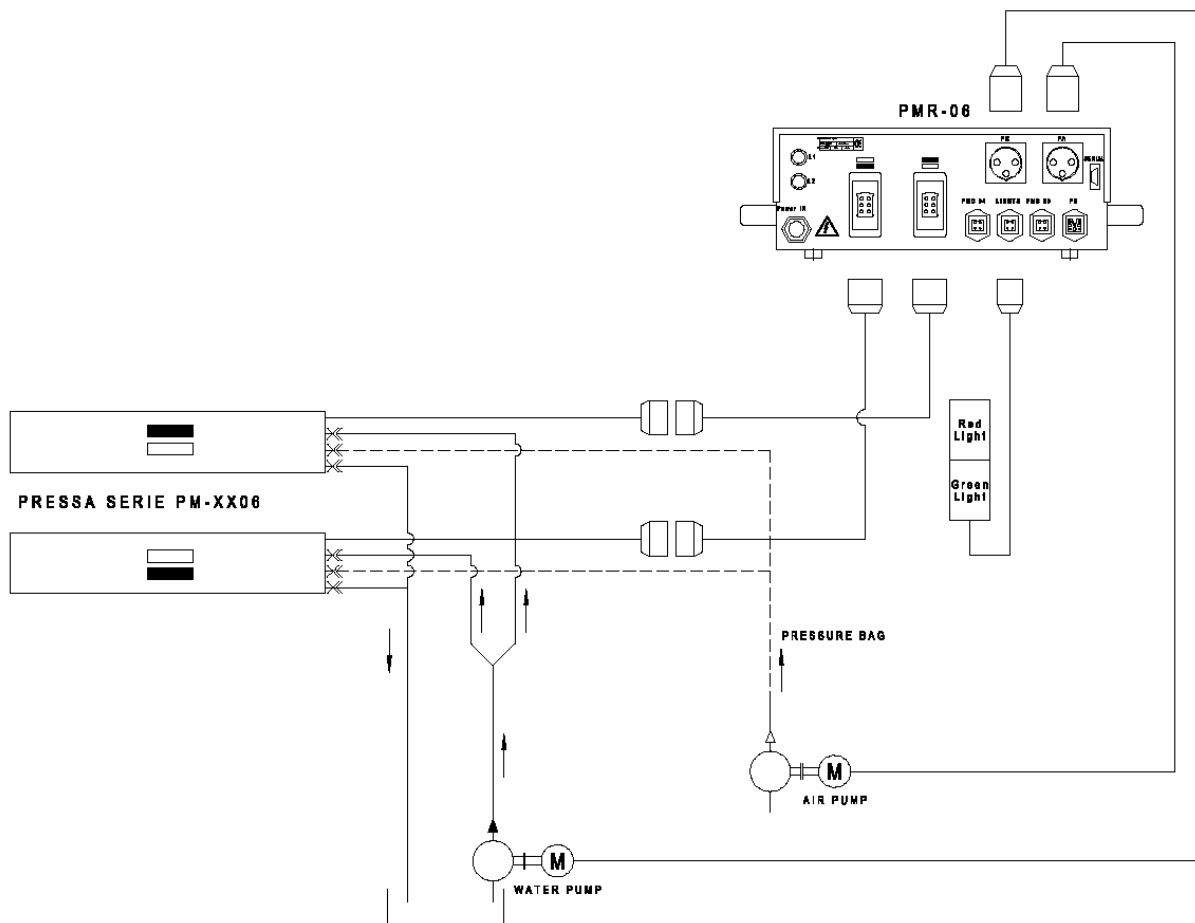
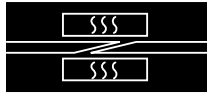

FIGURE 8 - MOBILE OPERATION USE WITH PMR-06



Author: A.T.
Edition: 09/2004
Replaces:

OPERATION
Page D-11

SECTION D.5 PRESS OPERATION

Section. D.5.1 FIXED AND MOBILE OPERATION WORKING

Fixed operation

Where the press is permanently positioned with available supplies of electricity, compressed air and water. For its operation the press is managed by the following:

A regulating unit PMR-XX, which guides the temperature raising stage, and the water-air control unit PMC-XX

A control unit PMC-XX, which guides the water circulation in the cooling system and subsequently empties the circuit as well as inflating and deflating the presser cushion (upper and lower).

Mobile operation

Where the press is not permanently positioned and is outside its normal working site. To be able to work without the normal equipment available, the press requires:

A regulating unit PMR-XX that guides the rise in temperature.

The availability of running water or a tank with immersion pump working in manual mode.

A portable manual mode air compressor.

Section. D.5.2 WORKING CYCLES

The press's working cycles are as follows.

This manual describes the press only. For the use of the regulating unit (PMR-XX) and the control unit (PMC-XX) see their own manuals.

Section. D.5.3 FIXED OPERATION USE

Check the working procedures for the belt/strap, checking guidelines 3210, 3220, 3225 or the individual technical sheet for the product.

Free the two fastening rods (4), turn them downwards and raise the upper part of the press (1). When opening out the rods make sure you do not bring them down heavily on the floor or supporting surface

Position the belt as required on the steel heat stabilizer (8) and fasten it, making sure it is flat.

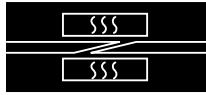

Author: A.T.
Edition: 09/2004
Replaces:

OPERATION
Page **D-12**

Position the upper part of the press (1) onto the lower part of the press (6) with the belt fastened to the heat stabilizer (8) and any inserts.
Turn the two fastening rods upwards (4) and evenly lock them at the two ends of the press
Ensure there is no liquid in the cooling circuit. This happens when the normal joining cycle is stopped (either deliberately or due to a black-out for example) during the cooling stage.

In this case it is necessary to act as follows:

Disconnect all electrical supply
Disconnect the pipes bring water into the press
Empty the press circuit using jets of compressed air.
When blowing air to expel water from the circuit, make sure the water does not come into contact with electrical equipment.
Using the regulation equipment PMR-XX (see its own manual) bring the pressure cushion up to the desired pressure to compress the belt
Using the regulating equipment PMR-XX (see its own manual) preselect the press's upper and lower temperatures
Using the regulating equipment PMR-XX (see its own manual) select the joining time.
Using the regulating equipment PMR-XX (see its own manual) start up the joining cycle.
When the joining cycle is completed the cooling cycle has to be started up
Wait for the end of the cooling cycle
Drinking water is used for cooling. In a fixed installation water softening is recommended.
Detailed consulting is available on request.

NOTE

If the cooling cycle is stopped before the end the circuit will not discharge all the water in the system. This may jeopardize the next joining cycle with resulting defective joints.

ATTENTION

The heated water can produce steam at 180° at a pressure of about 10 bars.

After the joining and subsequent cooling, by using the regulating equipment PMR-XX (see its own manual), with the manual valve you can discharge the pressure set at the pressure cushion.

Where standard production series are being carried out, do not lower the temperature below 80°C to reduce the heating time required for the next work cycle.

Open the hot press and carefully take the belt out and allow it to cool at room temperature.

ATTENTION

When you take the belt out, the press's parts are hot. Use suitable protective GLOVES.

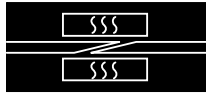

Section. D.5.4 MOBILE OPERATION USE

Check the working procedures for the belt/strap, checking guidelines 3210, 3220, 3225 or the individual technical sheet for the product.

Free the two fastening rods (4), turn them downwards and raise the upper part of the press (1). When opening out the rods make sure you do not bring them down heavily on the floor or supporting surface

Position the belt as required on the steel heat stabilizer (8) and fasten it, making sure it is flat. Position the upper part of the press (1) onto the lower part of the press (6) with the belt fastened to the heat stabilizer (8) and any inserts.

Turn the two fastening rods upwards (4) and evenly lock them at the two ends of the press. Ensure there is no liquid in the cooling circuit. This happens when the normal joining cycle is stopped (either deliberately or due to a black-out for example) during the cooling stage.

In this case it is necessary to act as follows:

Disconnect all electrical supply

Disconnect the pipes bring water into the press

Empty the press circuit using jets of compressed air.

When blowing air to expel water from the circuit, make sure the water does not come into contact with electrical equipment.

Use the portable compressor to bring the pressure cushion to compress the belt at the desired pressure.

Using the regulating equipment PMR-XX (see its own manual) preselect the press's upper and lower temperatures

Use the regulating equipment PMR-XX (see its own manual) to select the joining cycle seal times.

Using the regulating equipment PMR-XX (see its own manual) start up the joining cycle.

At the end of the joining cycle (see control equipment manual), it is necessary to manually manage the cooling of the press.

For this purpose the flexible water hose for the mobile refrigerator has to be connected to the connectors on the (5) hot press and the electric pump started up (see 1.3.1 Necessary accessories for mobile use).

Wait for the end of the set cooling cycle

Empty the air out of the presser cushions

Open the hot press and carefully take the belt out and allow it to cool at room temperature.

ATTENTION

When you take the belt out, the press's parts are hot. Use suitable protective GLOVES. Remove water from the cooling circuit with jets of compressed air, ensuring it is completely emptied.

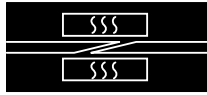

Author: A.T.
Edition: 09/2004
Replaces:

OPERATION
Page D-14

NOTE

If not all the water is removed from the cooling circuit this may jeopardize the next joining cycle with resulting defective joints.

ATTENTION

The heated water can produce steam at 180° at a pressure of about 10 bars.

For rapid heating without energy wastage, heat the hot press with it always closed.

Section. D.5.5 NOTES ON USE

ATTENTION

Never put the pressure chamber under pressure if the press has not been properly closed.
Do not exceed the maximum permitted pressure of 3 bars.

Section. D.5.6 TECHNICAL ASSISTANCE

Our experts will be available for you to consult on the use of the press. If you have any technical queries regarding the working and the status of the welding device, contact the manufacturer at the address indicated in this manual.

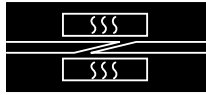

Author: A.T.
 Edition: 09/2004
 Replaces:

OPERATION
 Page D-15

SECTION D.6 TROUBLESHOOTING

ATTENTION

Maintenance, repairs and replacement operations for electrical components must be carried out by an ELECTRICAL MAINTENANCE TECHNICIAN or a QUALIFIED TECHNICIAN able to perform the works in accordance with safety regulations.

TABLE 16 - TROUBLESHOOTING

Faults	Solutions
No air	Check for air in the supply line.
No current	Check that the main switch is in "ON" position.
Fault in temperature rise (Probable presence of liquid in the cooling circuit)	<ul style="list-style-type: none"> - Disconnect all electrical supply - Disconnect the pipes that bring water into the press - Empty the press circuit using jets of compressed air. <p>ATTENTION! - When expelling water with compressed air, make sure no water comes into contact with any of the electrical equipment.</p>
Temperature deviation of a heating plate of more than 2°C with respect to the nominal value.	<p>Exchange the two connectors in the rear part of the regulating equipment and check whether the regulator always indicates the same anomalous value.</p> <p>In this case the fault can clearly be traced to the regulator in question.</p> <p>If the defect should pass to the other regulator, the fault can be attributed to the corresponding heating plate (7) or the thermocouple signal wire.</p> <p>In any case take a temperature reading of the heating plate if there is a discrepancy (see ROUTINE AND SCHEDULED MAINTENANCE).</p> <p>In case of faults of this or any other kind, the manufacturer should be informed. The heating plates (7) and the defective regulators can be repaired or replaced by the manufacturer.</p>
Electrical faults	<p>If a fault develops in the control/regulatory electronic unit, in the first place the automatic switches in the regulating unit should be checked.</p> <p>The automatic switches control output and are accessible from the outside. Supplementary automatic switches to control command current are located inside the regulating equipment.</p>

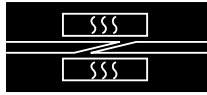

SECTION E - ORDINARY MAINTENANCE

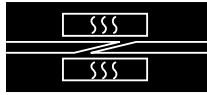

Author: A.T.
Edition: 09/2004
Replaces:

ORDINARY MAINTENANCE
Page **E-2**

SECTION E.1 GENERAL

ATTENTION

IT IS ESSENTIAL TO CARRY OUT PREVENTIVE MAINTENANCE OF THE PRESS TO PROTECT THE RELIABILITY OVER TIME OF ITS COMPONENTS AND PARTICULARLY ITS MOVING PARTS.

HARMFUL AGENTS SUCH AS DUST, ENCRUSTATION AND LIQUID SEDIMENTS CAN DAMAGE THE MACHINE'S COMPONENTS.

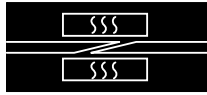

Author: A.T.
Edition: 09/2004
Replaces:

ORDINARY MAINTENANCE
Page **E-3**

SECTION E.2 GENERAL WARNINGS

The operator and/or the maintenance person has the following responsibilities:

To create on and around the machine the conditions so that the installed protective guards and devices are operationally effective, as they are there for the purpose of protecting personnel.

To observe the safety regulations described in the use and maintenance manual.

IMPORTANT

THE INFORMATION DEVICES (SIGNS) AND SAFETY NOTICES AFFIXED TO THE MACHINE MUST BE KEPT CLEAN AND LEGIBLE.

ATTENTION

DO NOT IN ANY WAY ALTER THE MACHINE'S SAFETY SYSTEM.

IT IS ABSOLUTELY FORBIDDEN TO REMOVE THE PROTECTIVE DEVICES INSTALLED ON THE MACHINE.

CARRYING OUT CLEANING AND MAINTENANCE JOBS WHILE THE SYSTEMS ARE LIVE OR UNDER PRESSURE IS ABSOLUTELY FORBIDDEN.

DO NOT REMOVE THE GUARDS WHICH REQUIRE TOOLS FOR THEIR REMOVAL.

DO NOT WEAR CLOTHES WITH WIDE SLEEVES.

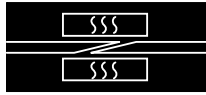

Author: A.T.
Edition: 09/2004
Replaces:

ORDINARY MAINTENANCE
Page **E-4**

SECTION E.3 ROUTINE AND SCHEDULED MAINTENANCE

IMPORTANT

Maintenance personnel must have knowledge of at least the following points:

- How the machine is protected.
- Mechanical and electrical safety devices
- Precautions to observe during maintenance, including how to work under safe conditions.
- Equipment and clothes to be worn to reduce the risks of accidents.
- Maintenance personnel must be authorized; and must not wear watches and finger-rings.

Section. E.3.1 PRELIMINARY OPERATIONS

ATTENTION

MAKE SURE THAT THE ELECTRICAL EQUIPMENT AND THE SYSTEM ARE NOT LIVE.
CHECK IF OTHER SOURCES OF ENERGY ARE DISABLED TOO; I.E., AIRE COMPRESSED
FEEDING.

ATTENTION

BEFORE ATTEMPTING ANY MAINTENANCE OPERATION ON THE LINE MAKE SURE THAT THE
SYSTEMS (ELECTRICAL, PNEUMATIC AND HYDRAULIC) ARE DISCONNECTED FROM THE
ENERGY SUPPLY SOURCES, THAT THE PNEUMATIC AND HYDRAULIC SYSTEMS ARE
SUITABLY DEPRESSURISED AND THAT THERE ARE NO RESIDUES OF POTENTIAL ENERGY
ON MOVING PARTS.



Author: A.T.
 Edition: 09/2004
 Replaces:

ORDINARY MAINTENANCE
 Page E-5

TABLE 17 - PERIODIC MAINTENANCE WORK

Operation	Period	Personnel	Method
General cleaning	Daily	Operator	Clean the press after use, removing dust and any deposits with a clean cloth without the use of solvents.
Check water connections	Daily	Maintenance worker	Check with your fingers that there are no water leaks. If the situation is overlooked for some time there may be calcium deposits visible.
Checking compressed air connections	Monthly	Maintenance worker	Listen for any air audible air leaks.
Check all the electrical cables on the machine in its fixed operation	Monthly	Maintenance worker	Check for defective insulation or connectors.
Check all the electrical cables on the machine in its mobile operation	Weekly	Maintenance worker	Check defective insulation or connectors.
Measurement of heating plates temperature	Monthly	Maintenance worker	<p>Position the heat-resistant expanded silicone rubber pad on the lower heating plate. Close the press normally. Submit the pressure chamber to a pressure of maximum 1 bar. Switch the heating on, set the nominal value at 180 °C and switch the time relay off.</p> <p>After 40 minutes heating time, open the press slightly lift the upper heating plate and insert a precision thermometer between the expanded silicone rubber pad and the upper heating plate, exactly in the center of the heating plate.</p> <p>Close the hot press (just under its own weight). Take a temperature reading after about 3 minutes.</p> <p>Repeat the procedure for the lower heating plate (insert the sensor under the expanded silicone rubber pad in the center of the heating plate). The temperature measured must be at 180 °C +/- 2 °C (max. measuring precision +/- 1 °C).</p> <p>If the temperature is not yet within the set range it will be necessary to adjust the temperature offset in the PMR-XX unit. (see its own manual)</p>

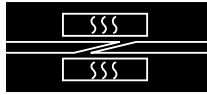

SECTION F - EXTRAORDINARY MAINTENANCE

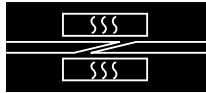

Author: S.D.T.
Edition: 09/2004
Replaces:

EXTRAORDINARY MAINTENANCE
Page F-2

SECTION F.1 EXTRAORDINARY MAINTENANCE

Section. F.1.1 ADJUSTMENTS, REPLACEMENTS AND SYNCHRONIZATION

IMPORTANT

All routine and extraordinary maintenance jobs must be done with the machine OFF, taking care with replacements and adjustments.
Maintenance jobs must be done by qualified technicians.

FOR ANY MAINTENANCE WORK THAT DOES NOT COME WITHIN THE CATEGORY OF ORDINARY MAINTENANCE WORK, CONTACT THE TECHNICAL ASSISTANCE OFFICE OF HABASIT.

Habasis Italiana S.p.A.
Via A. Meucci 8
Zona Industriale
I - 31029 Vittorio Veneto
Tel.: 0039. (0) 438.9113
Fax: 0039. (0) 438.200545

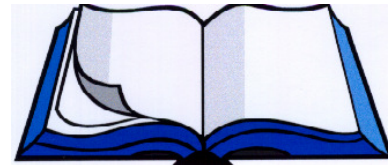



SECTION G - ELECTRICAL, WATER AND COMPRESSED AIR SYSTEM



Author: A.T.
 Edition: 09/2004
 Replaces:

SECTION G.1 ELECTRICAL, WATER AND COMPRESSED AIR SYSTEM

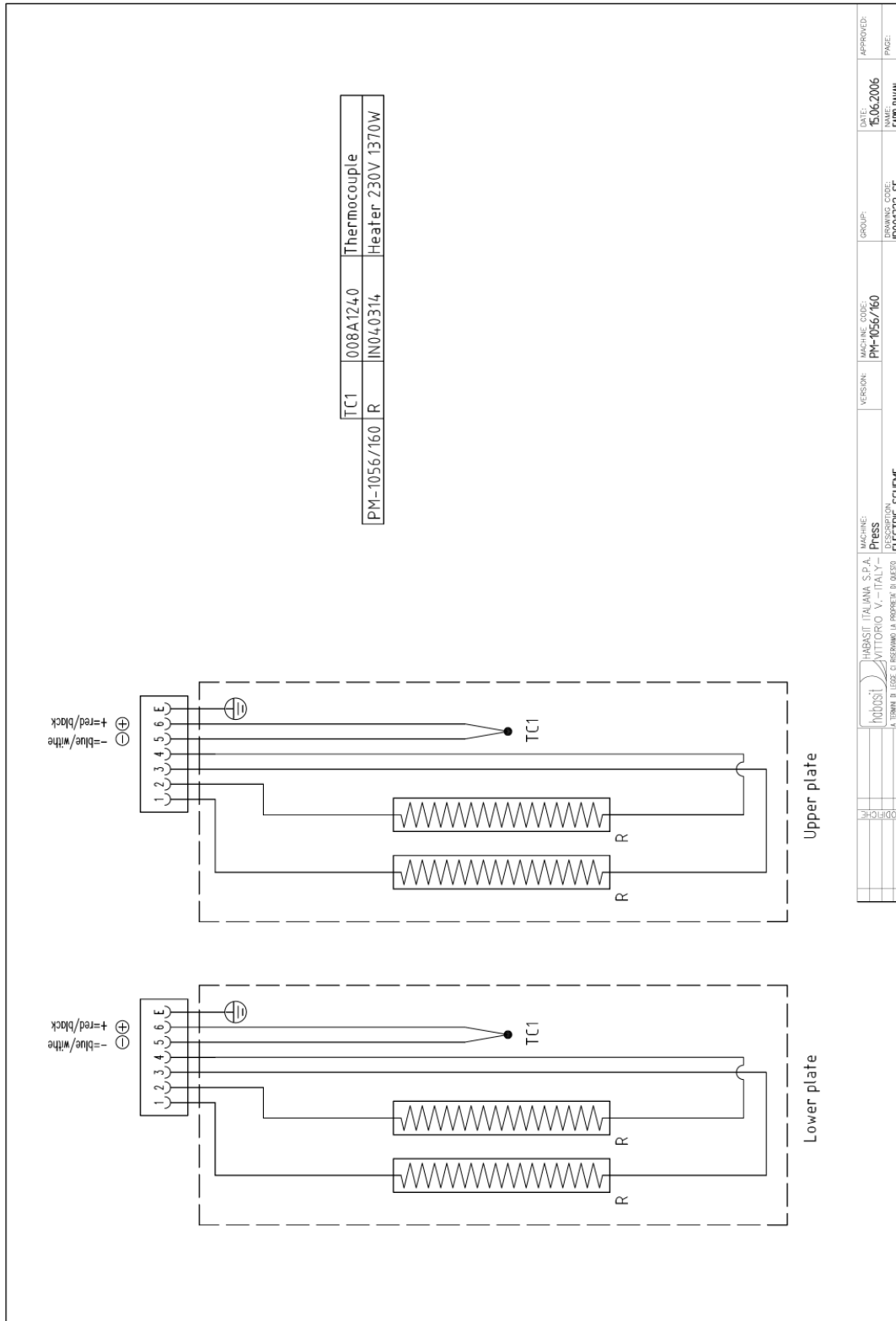
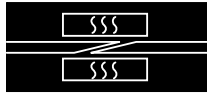
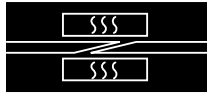

FIGURE 9 - PRESS WIRING LAYOUT PM-1056/160



SECTION H - GLOSSARY



Author: A.T.
 Edition: 09/2004
 Replaces:

GLOSSARY
 Page H-4

SECTION H.1 GLOSSARY OF TERMS

TABLE 18 - GLOSSARY

Terms	Description
PMR-XX	Equipment for the regulation and control of the rise in temperature of the press while managing the press's electrical circuitry. The suffix XX means that a range of different units may be used (PMR-04, PMR PMR-305 etc.) as long as compatible with the type of press in use (see Section. B.4.3 Regulating unit options)
PMC-XX	Press cooling control equipment with cooling and compressed air circuit management. The suffix XX means that various units can be used (PMC-04, PMC) provided they are compatible with the type of regulating unit in use (see Section. B.4.4 Control unit options)
Thermofix	Belt welding process (see manual 3210)
Flexproof	Belt welding process (see manual 3220 or 3225)
Heating box	The unit containing the heating plates and pressure cushion, designed to contain the heat and protect the operator
Lower Equalizer Sheet	Refers to lower belt support
Upper Equalizer Sheet	Refers to upper belt support
Presser	A bar that exerts pressure on the belt being worked on, to keep it in place.
Cushion (or AIRBAG)	Expandable airbag that exerts pressure on the presser
Molletton	Fabric used during joining

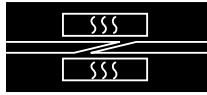

SECTION I - SPARE PARTS

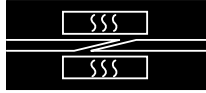

Author: A.T.
 Edition: 09/2004
 Replaces:

SPARE PARTS
 Page I-2

SECTION I.1 INTERNAL SPARE PARTS

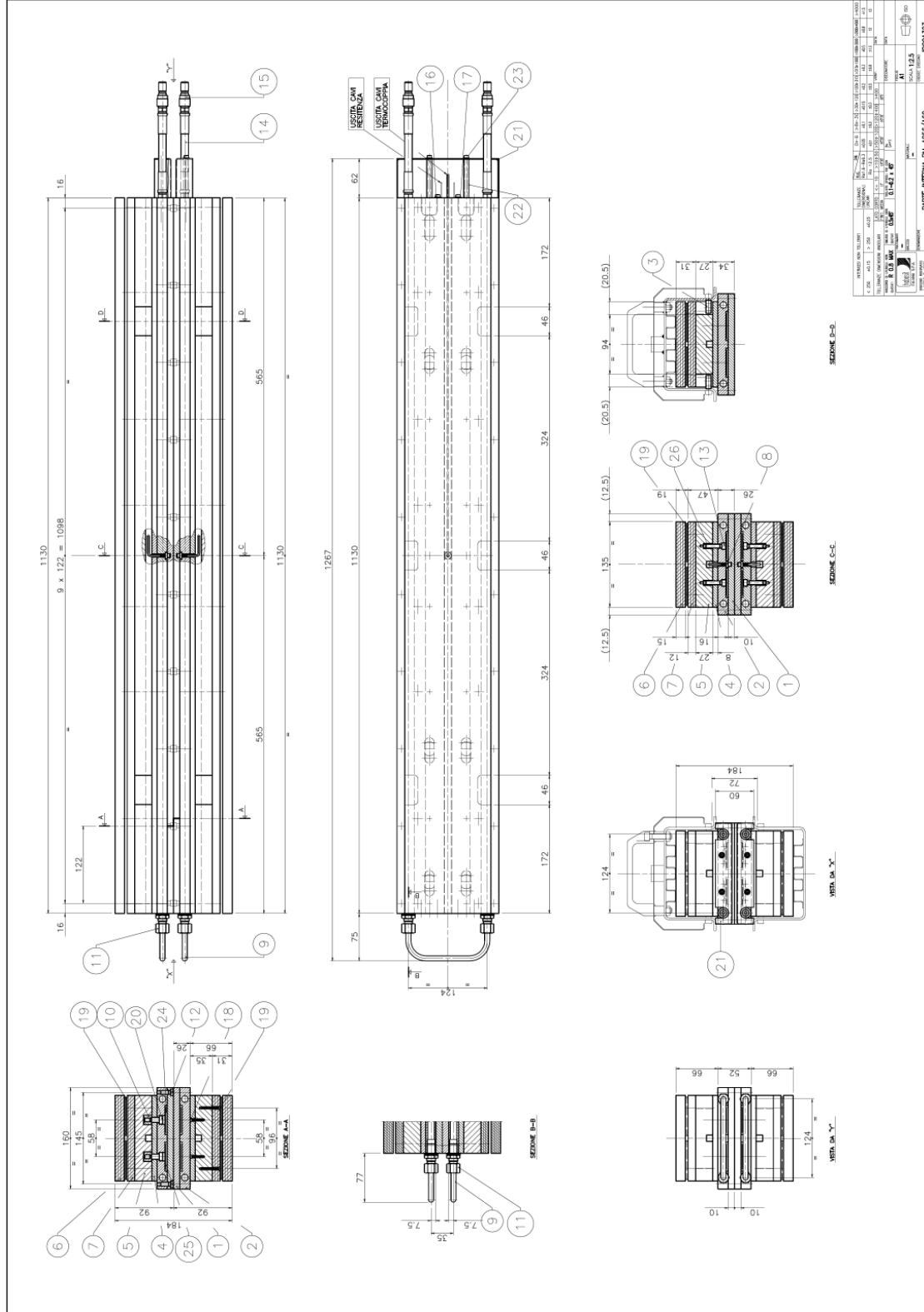
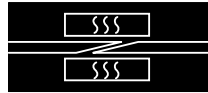

FIGURE 10 - INTERNAL SPARE PARTS



Author: A.T.
 Edition: 09/2004
 Replaces:

SPARE PARTS
 Page I-3

TABLE 19 - SPARE PARTS AND INTERNAL PARTS

Pos.	Code	Description	M.U.	Q.ty
1	ID001308	EXTERNAL PROFILE	N°	2
2	ID001309	INTERNAL PROFILE	N°	2
3	008A1070	SECTION FASTENING WITH ROUND HOLE	N°	12
4	ID001310	INSULATOR M59 TH.8	N°	2
5	ID001311	SPACER TH.27	N°	2
6	IN060698	MULTILAYER BEECH WOOD MM135x1130 TH.15	N°	2
7	ID002553	SPACER	N°	2
8	008A1240	THERMOCOUPLE	N°	2
9	205C1110	PASSING WATER PIPE	N°	2
10	ID001312	STAINLESS STEEL PLATE	N°	16
11	IN020418	FITTING SERIE 510 8 LR 14C	N°	4
12	IN011310	HH SCREW DIN 7984-M6x16 lowered head STAINLESS STEEL A2	N°	40
13	IN010204	HH SCREW UNI 5931-M6x25 STAINLESS STEEL	N°	4
14	205C1170	FEED AND DISCHARGE TUBE	N°	4
15	IN020416	MALE COUPLING 162A 1/4" FEMALE	N°	4
16	IN010848	HH SCREW UNI 5931-M4x10 STAINLESS STEEL	N°	2
17	IN010202	WASHER 6592-4.3x9 STAINLESS STEEL	N°	2
18	IN011443	Screw for hardboard panels with cross slotting d4x20	N°	64
19	ID001321	PRESSER CUSHION L=1050	N°	2
20	IN011661	SHOULDER SCREW d8 M6x12	N°	16
21	ID003119	PROTECTION SHIELD	N°	2
22	ID003118	SPACER d4.2D8L60.8	N°	4
23	IN011971	HH SCREW UNI 5931-M4x70	N°	4
24	IN040314	ELECTRICAL HEATER 230V 1370W	N°	4
25	IN060091	FIBER GLASS FABRIC L1.13M	N°	4
26	IN011980	ENSAT BUSH M6 302 0 060.16	N°	4

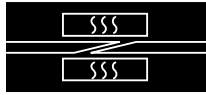

Author: A.T.
Edition: 09/2004
Replaces:

SPARE PARTS
Page I-5

TABLE 20 - SPARE PARTS AND PRESSER CUSHION

Pos.	Code	Description	M.U.	Qty.
1	IN060782	FLATTENING TUBE Ø 32 cod.1640860 IVG COLBACHINI	N°	2
2	IN020946	HOSE END-ACCESSORY code 3040-8-1/8 AIGNEP	N°	1
3	ID002698	REAR CUSHION RESTRAINING PLATE	N°	1
4	ID002699	REAR CUSHION RESTRAINING PLATE	N°	1
5	ID002700	FRONT CUSHION RESTRAINING PLATE	N°	1
6	ID002901	FRONT CUSHION RESTRAINING PLATE	N°	1

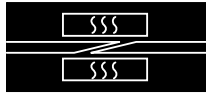

Author: A.T.
 Edition: 09/2004
 Replaces:

SPARE PARTS
 Page I-6

SECTION I.3 EXTERNAL SPARE PARTS

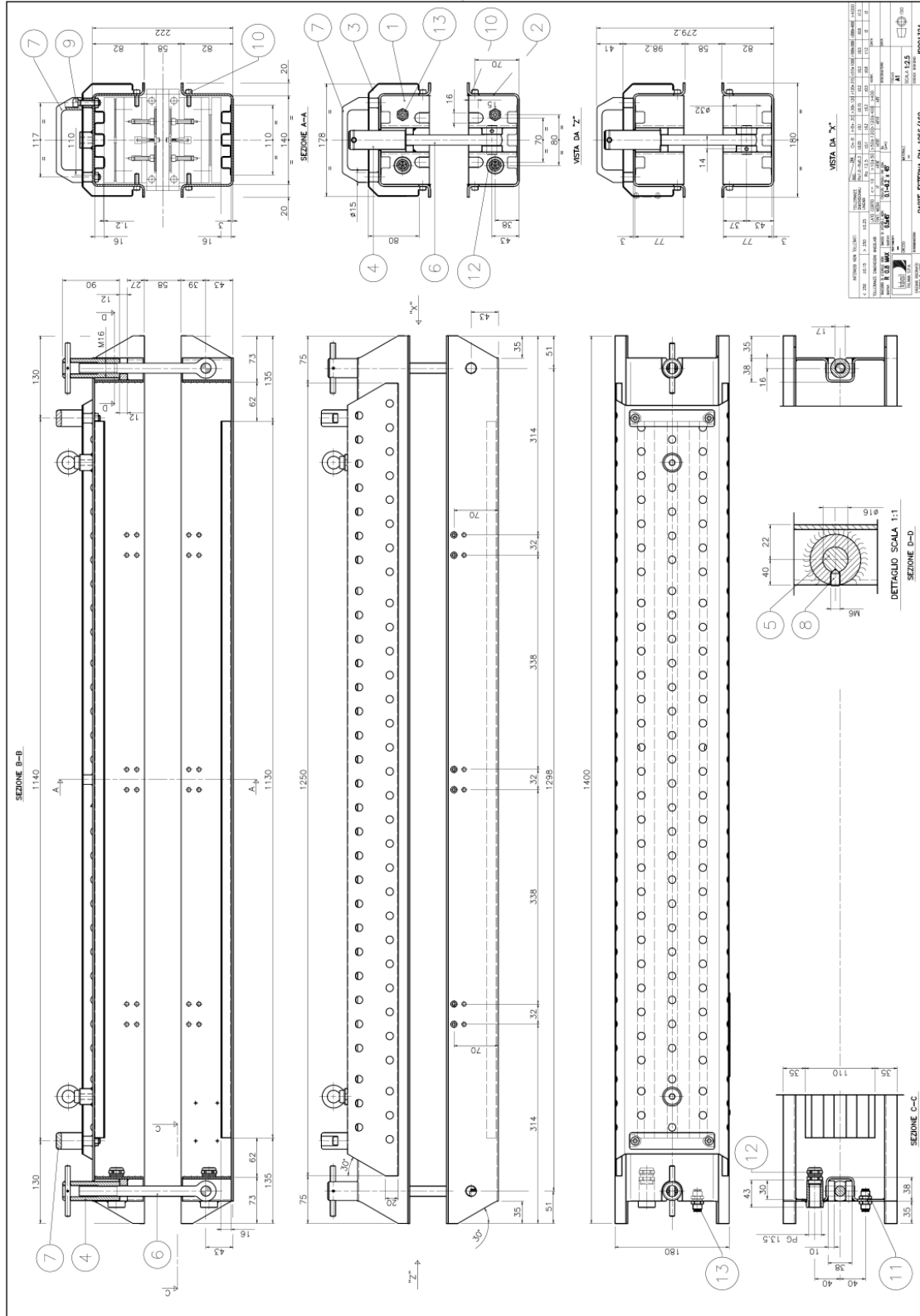
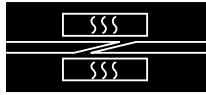

FIGURE 12 - EXTERNAL SPARE PARTS



Author: A.T.
Edition: 09/2004
Replaces:

SPARE PARTS
Page I-7

TABLE 21 - EXTERNAL SPARE PARTS

Pos.	Code	Description	M.U.	Qty.
1	ID001318	UPPER BEAM	N°	1
2	ID001317	LOWER BEAM	N°	1
3	007C1030	UPPER PROTECTION	N°	1
4	008C1040	KNOB	N°	2
5	008C1050	PIN	N°	2
6	ID001304	SCREW EYE	N°	2
7	IN060003	M. 443/140 N 37131 HANDLE	N°	2
8	IN011445	TIP PIN UNI ISO 5927 M6X10	N°	2
9	IN010126	CHH SCREW UNI 5931-M8x35 GALVANIZED	N°	4
10	IN010020	CHH SCREW UNI 5931-M6x20 GALVANIZED	N°	24
11	IN020951	QCK-1/8-PK-4-B through connector cod.9425	N°	2
12	IN040201	CABLE CLAMP art. 1300.13.06.35 ELEKTROZUBEHÖR	N°	2
13	IN020953	MALE COUPLING 11 MINI 1/8" COD. 0102011	N°	2

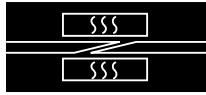

Author: A.T.
 Edition: 09/2004
 Replaces:

SPARE PARTS
 Page I-8

SECTION I.4 BELT LOCKING SYSTEM SPARE PARTS

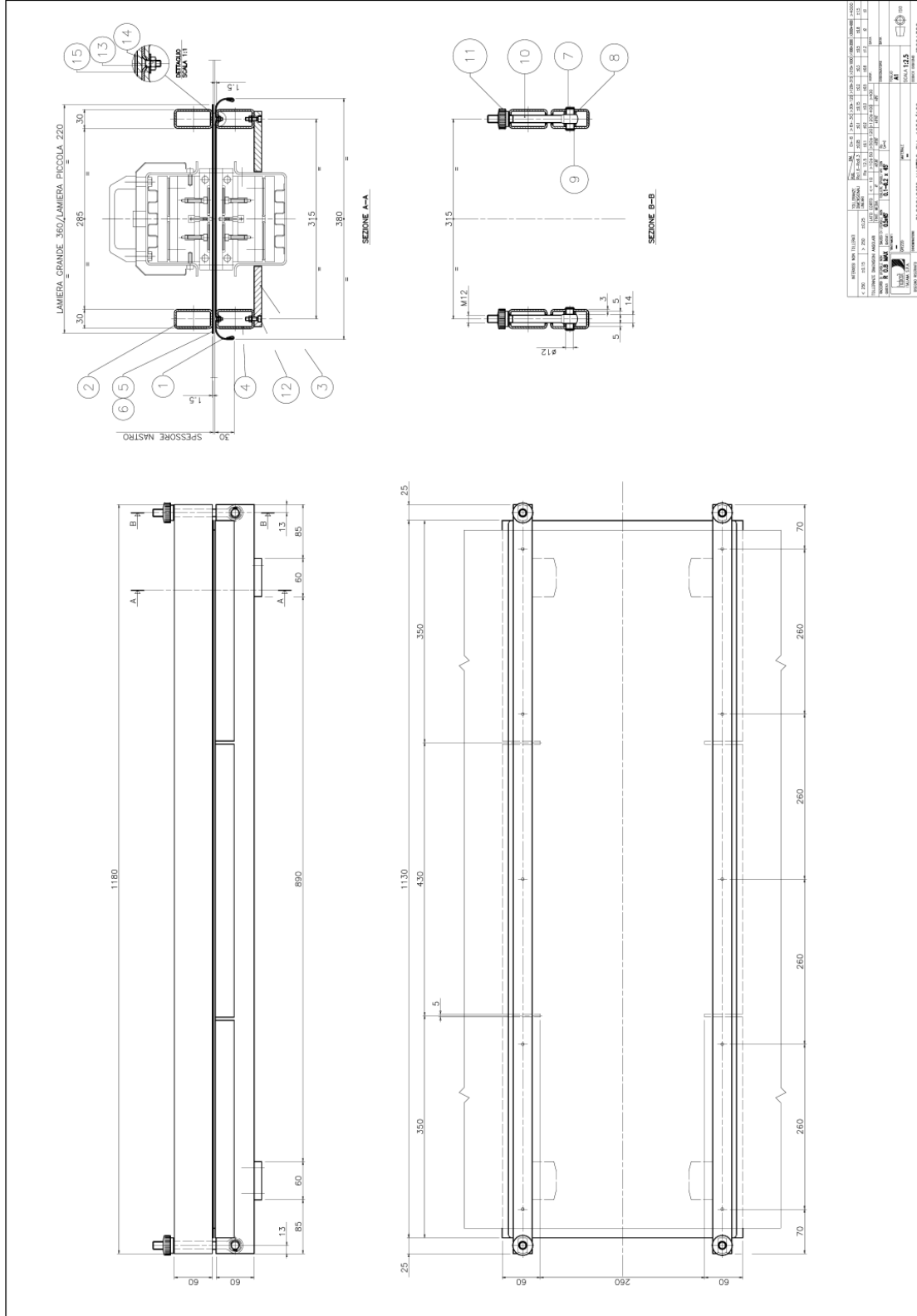
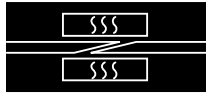

FIGURE 13 - BELT LOCKING SYSTEM SPARE PARTS



Author: A.T.
Edition: 09/2004
Replaces:

SPARE PARTS
Page I-9

TABLE 22 - BELT LOCKING SYSTEM SPARE PARTS (CODE ID001320)

Pos.	Code	Description	M.U.	Qty.
1	ID001998	SHEET STEEL SURFACE PM-1056/160	N°	1
2	ID002103	UPPER PRESSER	N°	2
3	ID001319	SPACER	N°	4
4	ID001999	LOWER PRESSER	N°	2
5	ID002101	SMALL JOINING SHEET	N°	1
6	ID002102	LARGE JOINING SHEET	N°	1
7	205D1050	PRESSER CLOSURE SCREW PIN	N°	4
8	205D1060	SCREW EYE SPACER	N°	8
9	IN010149	EXTERNAL SEEGER e12 UNI 7435	N°	8
10	IN010144	DIN 444 M12x130 SCREW EYE code GN.12536	N°	4
11	IN010496	B. 193/30 FP-M12 KNURLED KNOB cod. 2514	N°	4
12	IN010114	CHH SCREW UNI 5931-M5x16 GALVANIZED	N°	8
13	IN010582	OHH SCREW UNI 5933-M4x12 GALVANIZED	N°	10
14	IN010148	UNI 5588-68 M4 GALVANIZED NUT	N°	10
15	IN010172	UNI 6592-4.3x9 GALVANIZED WASHER	N°	10
16	IN010113	UNI 5588-68 M5 ZINC.	N°	8
17	IN010061	UNI 6592-5.3x10 ZINC. GALVANIZED WASHER	N°	8

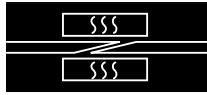

Author: A.T.
 Edition: 09/2004
 Replaces:

SPARE PARTS
 Page I-10

SECTION I.5 SPARE PARTS FOR COMPRESSED AIR CONNECTION

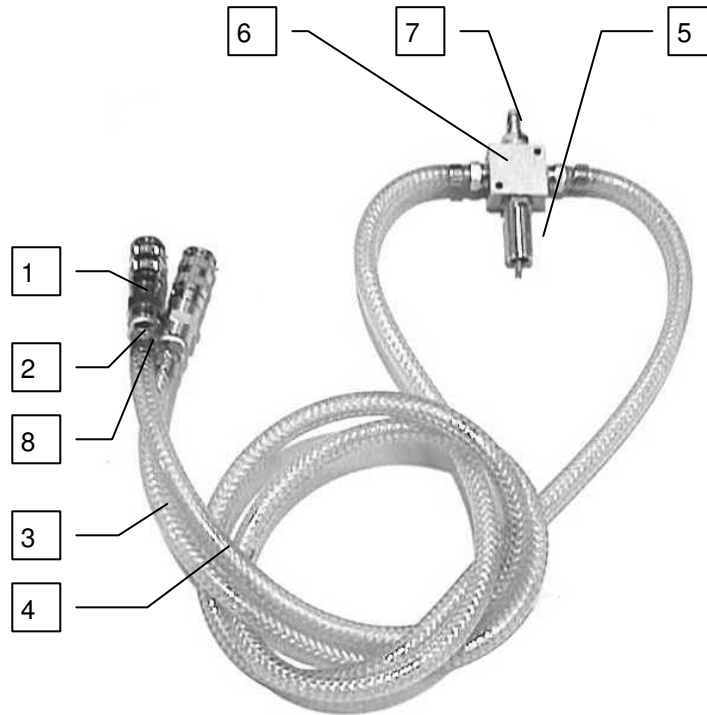
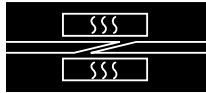

FIGURE 14 - SPARE PARTS FOR COMPRESSED AIR CONNECTION

TABLE 23 - SPARE PARTS FOR COMPRESSED AIR CONNECTION (CODE 008E1000)

Pos.	Code	Description	M.u.	Qty.
	008E1000	AIR CONNECTION	NR	1
1	IN020655	FEMALE COUPLING 04 MINI 1/4" code 01010004	NR	2
2	IN020407	HOSE-END FITTING 6x1/4" code 1.13234	NR	4
3	IN020410	PLASTIC TUBE PVC 6x12 code TA06	NR	1
4	IN020410	PLASTIC TUBE PVC 6x12 code TA06	NR	1
5	IN020406	SAFETY VALVE F. 1/4" CALIBRATED AT 3 bars AND PUNCHED code 1.441	NR	1
6	IN020950	DIVIDER AD "X" F.F.F.F. 1/4" code 150.4	NR	1
7	IN020656	CORE COUPLING 12 mini 1/4" code 0102012	NR	1
8	IN020412	COLLAR WITH TWO EARS COL-PI 11x13	NR	4



Author: A.T.
 Edition: 09/2004
 Replaces:

SPARE PARTS
 Page I-11

SECTION I.6 SPARE PARTS FOR ELECTRICAL, WATER AND COMPRESSED AIR CONNECTIONS

TABLE 24 - SPARE PARTS FOR ELECTRICAL, WATER AND AIR CONNECTIONS USED IN FIXED OPERATION

Pos.	Description	M.U.	Qty.	Assembly code	Parts code
	CABLE CONNECTION PAIR REGULATOR PMR-04/PMR-06 AND OUTLET PM.	N°	1	691011	
	PNEUMATIC CONNECTION	N°	1	20501000	
	PLASTIC TUBE PVC 6x12 code TA06	ML	5 m.		IN020410
	TUBE CLAMP 14x24 MINUSSGM	N°	12		IN020411
	COLLAR WITH TWO EARS COL-PI 11x13	N°	3		IN020412
	FEMALE COUPLING 1/4" code 403 1/4SV (RAPID FIT)	N°	4		IN020413
	HOSE-END ACCESSORY 12x1/4" CH 17	N°	4		IN020371
	HOSE-END ACCESSORY 6x1/4" code 1.13234	N°	1		IN020407
	MANITOBA TUBE D.10x21mm 170° L=20ml	N°	1		IN020429
	COPPER WASHER 1/4"	N°	4		IN010146
	FEMALE COUPLING 04 MINI 1/4" code 01010004	N°	1		IN020655



Author: A.T.
 Edition: 09/2004
 Replaces:

SPARE PARTS
 Page I-12

TABLE 25 - SPARE PARTS FOR ELECTRICAL, WATER AND AIR CONNECTIONS USED IN MOBILE OPERATION

Pos.	Description	M.U.	Q.ty	Assembly code	Parts code
	CABLE CONNECTION PAIR REGULATOR PMR-04/PMR-06 AND OUTLET PM	N°	1	691011	
	MOBILE COOLING UNIT. The control unit may depend on the electrical tension available.	N°	1		
	MOBILE COOLING UNIT PM-4/7 230V	N°		691016	
	MOBILE COOLING UNIT 120V	N°		691015	
	IMMERSION PUMP 220V	N°	1		709000
	IMMERSION PUMP 120V	N°	1		709002
	The following parts are in common irrespective of the tension applied to the pump				
	50 LITER BIN	N°	1		709003
	COOLING WATER DISCHARGE TUBE PM-04/6/7	N°	1		700021
	TUBE COLLAR - DIAM 100MM M10	N°	1		700500
	FEMALE CONNECTION 1/4" code 403 1/4SV	N°	4		IN020413
	RUBBER HOSE FOR AIR/WATER 20 BAR 25 INT 37 EXT	MT	0.16		702508
	RUBBER HOSE FOR AIR/WATER 20 BAR 16 INT 26 EXT	MT	10		702509
	RUBBER HOSE FOR AIR/WATER 20 BAR 13 INT 23 EXT	MT	10		702511
	PMR-06 OUTPUT ADAPTOR	N°	1		IN040301
	MOBILE MINI COMPRESSOR. The control unit may vary according to the electrical tension available	N°	1		
	MOBILE MINI COMPRESSOR PM-4/7 230V	N°		691017	
	MOBILE MINI COMPRESSOR 120V	N°		691018	
	MINI COMPRESSOR 220V	N°	1		709001
	MINI COMPRESSOR 120V	N°	1		709004
	The following parts are in common irrespective of the tension applied to the compressor				
	RADIAL MANOMETER 1/4" GLICER 1-6 BAR	N°	1		700516
	FAUCET SERIES A/4» F-F	N°	1		700517
	FEMALE CONNECTION 04 MINI 1/4" code 0101004	N°	1		IN020655
	COLLAR WITH TWO EARS COL-PI 11x13	N°	1		IN020412
	PLASTIC TUBE PVC 6x12 code TA06	N°	5		IN020410
	PMR-06 OUTPUT ADAPTOR	N°	1		IN040301
	CONNECTION ADAPTOR DIRECT TO PMR-06 (only for 230V)	N°	1		N-26964

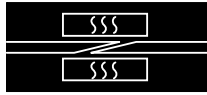

SECTION J - ANNEXED COMMERCIAL DOCUMENTS

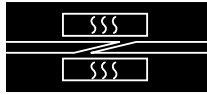

Author: S.D.T.
Edition: 01/2002
Replaces:

ANNEXED COMMERCIAL DOCUMENTS

Page **J-2**

SECTION J.1 WATER CIRCULATION PUMP



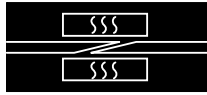

Author: S.D.T.
Edition: 01/2002
Replaces:

ANNEXED COMMERCIAL DOCUMENTS

Page **J-3**

SECTION J.2 PORTABLE COMPRESSOR



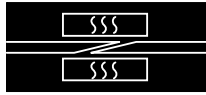

Author: S.D.T.
Edition: 01/2002
Replaces:

ANNEXED COMMERCIAL DOCUMENTS

Page **J-4**

Product liability, application considerations

If the proper selection and application of Habasis products are not recommended by an authorized Habasis sales specialist, the selection and application of Habasis products, including the related area of product safety, are the responsibility of the customer.

All indications / information are recommendations and believed to be reliable, but no representations, guarantees, or warranties of any kind are made as to their accuracy or suitability for particular applications. The data provided herein are based on laboratory work with small-scale test equipment, running at standard conditions, and do not necessarily match product performance in industrial use. New knowledge and experiences can lead to modifications and changes within a short time without prior notice.

BECAUSE CONDITIONS OF USE ARE OUTSIDE OF HABASIT'S AND ITS AFFILIATED COMPANIES CONTROL, WE CANNOT ASSUME ANY LIABILITY CONCERNING THE SUITABILITY AND PROCESS ABILITY OF THE PRODUCTS MENTIONED HEREIN. THIS ALSO APPLIES TO PROCESS RESULTS / OUTPUT / MANUFACTURING GOODS AS WELL AS TO POSSIBLE DEFECTS, DAMAGES, CONSEQUENTIAL DAMAGES, AND FURTHER-REACHING CONSEQUENCES.
