

# HOT PRESS

Type : PM-2006

## GENERAL MANUAL USE AND MAINTENANCE



ORDER :

S.N. :

**Habasit Italiana S.p.A. - Via A. Meucci 8 Zona Industriale - I - 31029 Vittorio Veneto**

This document is the property of HABASIT ITALIANA and, therefore, must not be passed on to persons or Bodies outside the sphere of the Company unless previously authorized by the Technical Department for Industrial and Quality Systems.



## FOREWORD

### IMPORTANT

BEFORE INSTALLING, SETTING UP AND OPERATING THE HOT-PRESSING DEVICE, THE CUSTOMER MUST CAREFULLY READ THIS MANUAL AND CAREFULLY FOLLOW THE INSTRUCTIONS IT CONTAINS IN ORDER TO ENSURE THE HOT-PRESSING DEVICE IS USED SAFELY AND CORRECTLY.

ALL OPERATORS AND/OR MAINTENANCE PERSONNEL MUST KNOW THIS MANUAL TO ENABLE THEM TO WORK SAFELY ON THE HOT-PRESSING DEVICE.





## SUMMARY

<b>A.</b>	<b>REGULATIONS AND GENERAL WARNING NOTES.....</b>	<b>A-1</b>
A.1	Reading assistance notes .....	A-2
A.2	How the manual is organized .....	A-3
A.3	Use criteria.....	A-4
A.4	Guarantee conditions.....	A-5
A.4.1	Guarantee terms and validity.....	A-5
A.4.2	When the guarantee can be voided.....	A-5
A.5	Visual signs.....	A-6
A.5.1	Signs.....	A-6
A.6	Safety warnings .....	A-10
A.7	Remaining risks .....	A-11
A.8	Qualification of personnel .....	A-12
A.9	References and standards .....	A-13
A.9.1	Applicable EU Directives .....	A-13
A.9.2	EU Directives concerning safety in the workplace .....	A-13
A.9.3	EU Directives concerning personal protection .....	A-13
A.9.4	EU Directives concerning environmental protection.....	A-13
<b>B.</b>	<b>TECHNICAL SPECIFICATIONS.....</b>	<b>B-1</b>
B.1	Purpose of the hot-pressing device .....	B-2
B.2	Press identification data.....	B-3
B.3	Technical characteristics of the hot-pressing device.....	B-4
B.4	Equipment and accessories provided.....	B-6
B.4.1	Necessary accessories for stationary use.....	B-6
B.4.2	Necessary accessories for mobile use .....	B-7
B.4.3	Regulating unit options .....	B-8
B.4.4	Cooling unit options .....	B-8
B.4.5	Optional accessories for both stationary and mobile use.....	B-9
B.5	Ordering of accessories and spare parts.....	B-10
<b>C.</b>	<b>INSTALLATION .....</b>	<b>C-1</b>
C.1	Preparation of working area .....	C-2
C.2	Packing and handling .....	C-3
C.2.1	Handling – Stationary use .....	C-3
C.2.2	Handling – Mobile use .....	C-4
C.3	Assembling and installation .....	C-5
C.3.1	Positioning .....	C-5
C.3.2	Connection of air and water supplies .....	C-5
C.3.3	Electrical connection.....	C-6
C.4	Disassembling of the hot-pressing device.....	C-7
C.5	Storage .....	C-8
C.6	Disposal .....	C-9



<b>D.</b>	<b>OPERATION .....</b>	<b>D-1</b>
D.1	General warnings.....	D-2
D.2	Guards installed.....	D-3
D.3	Identification of press' parts.....	D-5
D.3.1	View of PM-2006 .....	D-5
D.3.2	Main elements of the PM-2006.....	D-6
D.3.3	Pneumatic connection .....	D-7
D.4	Hot-pressing device's configuration.....	D-8
D.4.1	Stationary operation use.....	D-8
D.4.2	Mobile operation use .....	D-10
D.5	Press operation.....	D-11
D.5.1	Working stationary and mobile .....	D-11
D.5.2	Working cycles.....	D-11
D.5.3	Stationary operation use.....	D-11
D.5.4	Mobile operation use .....	D-13
D.5.5	Notes on use.....	D-14
D.5.6	Technical assistance .....	D-14
D.6	Troubleshooting .....	D-15
<b>E.</b>	<b>ORDINARY MAINTENANCE.....</b>	<b>E-1</b>
E.1	General .....	E-2
E.2	General warnings.....	E-3
E.3	Routine and scheduled maintenance .....	E-4
E.3.1	Preliminary operations .....	E-4
<b>F.</b>	<b>EXTRAORDINARY MAINTENANCE.....</b>	<b>F-1</b>
F.1	Extraordinary maintenance.....	F-2
F.1.1	Adjustments, replacements and synchronization .....	F-2
<b>G.</b>	<b>ELECTRICAL, WATER AND COMPRESSED AIR SYSTEM.....</b>	<b>G-1</b>
G.1	Electrical, water and compressed air system .....	G-2
<b>H.</b>	<b>GLOSSARY.....</b>	<b>H-1</b>
H.1	Glossary of terms.....	H-2
<b>I.</b>	<b>SPARE PARTS .....</b>	<b>I-1</b>
I.1	Internal spare parts.....	I-2
I.2	Spare parts of pressure cushion.....	I-4
I.3	External spare parts.....	I-6
I.4	Spare parts of belt clamping system .....	I-8
I.5	Spare parts for pneumatic connection.....	I-10
I.6	Spare parts for electrical, water and compressed air connections.....	I-11
<b>J.</b>	<b>ANNEXED COMMERCIAL DOCUMENTS.....</b>	<b>J-1</b>
J.1	Water circulation pump .....	J-2
J.2	Portable compressor.....	J-3



## SUMMARY OF FIGURES

FIGURE 1 - MACHINE IDENTIFICATION PLATE .....	B-3
FIGURE 2 - POSITION OF SIGNS ON THE PRESS .....	D-4
FIGURE 3 - VIEW OF PM-2006 .....	D-5
FIGURE 4 - MAIN ELEMENTS OF THE PM-2006 .....	D-6
FIGURE 5 - PNEUMATIC CONNECTION .....	D-7
FIGURE 6 - STATIONARY OPERATION USE WITH PMR-06 AND PMC-04 .....	D-8
FIGURE 7 - STATIONARY OPERATION USE WITH PMR-06 AND PMC-06 .....	D-9
FIGURE 8 - MOBILE OPERATION USE WITH PMR-06 .....	D-10
FIGURE 9 - PRESS WIRING LAY-OUT .....	G-2
FIGURE 10 - INTERNAL SPARE PARTS .....	I-2
FIGURE 11 - PRESSER CUSHION SPARE PARTS .....	I-4
FIGURE 12 - EXTERNAL SPARE PARTS .....	I-6
FIGURE 13 - BELT LOCKING SYSTEM SPARE PARTS .....	I-8
FIGURE 14 - SPARE PARTS FOR PNEUMATIC CONNECTION .....	I-10

## SUMMARY OF TABLES

TABLE 1 - DANGER SIGNS .....	A-7
TABLE 2 - PRESCRIPTIVE SIGNS .....	A-7
TABLE 3 - TERMS AND DEFINITIONS .....	A-8
TABLE 4 - QUALIFICATIONS .....	A-12
TABLE 5 - ELECTRICAL CHARACTERISTICS OF THE HEATERS .....	B-4
TABLE 6 - PNEUMATIC CHARACTERISTICS .....	B-4
TABLE 7 - WATER CHARACTERISTICS .....	B-4
TABLE 8 - DIMENSIONS AND ENVIRONMENTAL CHARACTERISTICS .....	B-5
TABLE 9 - CHARACTERISTICS OF WORKABLE ELEMENTS .....	B-5
TABLE 10 - NECESSARY ACCESSORIES FOR STATIONARY USE .....	B-6
TABLE 11 - ACCESSORIES NECESSARY FOR MOBILE USE .....	B-7
TABLE 12 - REGULATING UNIT OPTIONS (PMR-XX) (PRESS-XX COMBINATIONS) .....	B-8
TABLE 13 - CONTROL UNIT OPTIONS (PMC-XX) (PMR-XX – PMC-XX COMBINATIONS) .....	B-8
TABLE 14 - OPTIONAL ACCESSORIES (FOR BOTH STATIONARY AND MOBILE USE) .....	B-9
TABLE 15 - STORAGE CONDITIONS .....	C-8
TABLE 16 - TROUBLESHOOTING .....	D-15
TABLE 17 - PERIODIC MAINTENANCE WORK .....	E-5
TABLE 18 - GLOSSARY .....	H-2
TABLE 19 - SPARE PARTS AND INTERNAL PARTS .....	I-3
TABLE 20 - SPARE PARTS AND PRESSER CUSHION L=1600 .....	I-5
TABLE 21 - EXTERNAL SPARE PARTS .....	I-7
TABLE 22 - BELT LOCKING SYSTEM SPARE PARTS .....	I-9
TABLE 23 - SPARE PARTS FOR PNEUMATIC CONNECTION .....	I-10
TABLE 24 - SPARE PARTS FOR ELECTRICAL, WATER AND AIR CONNECTIONS USED IN STATIONARY OPERATION .	I-11
TABLE 25 - SPARE PARTS FOR ELECTRICAL, WATER AND AIR CONNECTIONS USED IN MOBILE OPERATION .....	I-12



**A. REGULATIONS AND GENERAL WARNING NOTES**



## **A.1 Reading assistance notes**

Meanings of notes used in this manual:

### **ATTENTION**

Note of particular interest for the safety of the people running and maintaining the hot-pressing device.

### **WARNING**

Note of particular interest concerning the safety of the hot-pressing device.

### **NOTE**

*A request for the reader's attention referred to the subsequent paragraph.*



## **A.2 How the manual is organized**

This hot-pressing device was designed, built and tested by expert technicians. The high quality materials used to build the hot-pressing device make it operationally highly reliable.  
For further, more detailed information or in regard to problems, please contact our the following address:

**Habasis Italiana S.p.A.**  
**Via A. Meucci 8**  
**Zona Industriale**  
**I - 31029 Vittorio Veneto**  
**Tel.: 0039.(0)438.9113**  
**Fax: 0039.(0)438.200545**

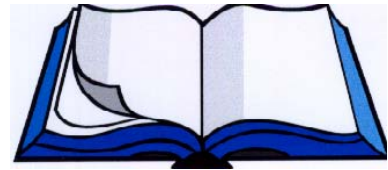

This manual observes the organizational rules and requirements of Directive 98/37/CE, duly amended, being the Directive of the Council of the European Community of June 14, 1989, concerning the reconciliation of the laws of member states regarding machines, also known as the «Machine Directive», and also all the other Directives and Regulations referred to in the said Machine Directive, inspired by criteria which, in addition to illustrating the technical characteristics of the machine and its use, maintenance and troubleshooting methods, also clearly indicate the following:

All the protection measures adopted on the hot-pressing device, fully integrating design safety planning and construction safety

All protection measures to be adopted to meet those risks that cannot be completely eliminated

All indications for the training of personnel using the hot-pressing device, while indicating where it is necessary to provide for individual safety protection devices.

The manual is divided up into sections. Each section deals with a specific subject in which every aspect of safety is considered and clearly highlighted in the text.



### **A.3 Use criteria**

HABASIT requests the Customer to fully read this manual on delivery of the hot-pressing device it accompanies, and always before attempting any action on the hot-pressing device. This manual is arranged to supply all the instructions, indications and warnings the user may need in order to know the hot-pressing device, understand its operating principles, and to be adequately informed to ensure safe use.

In addition to the instructions in this manual, we would ask users to observe any specific current laws. This manual must be considered as an essential part of the machine. Its content must be made known to the entrusted maintenance persons and users.

The purpose is to provide all the information required for good, correct use of the device.

The manual must be kept throughout the life of the hot-pressing device and must be updated in the event of modifications aimed at improving the device's performance.

The manual must be available to qualified personnel.

Consultation of this manual is facilitated by the general index on the first page, which makes it possible to immediately find the subject of interest.

If the subject dealt with is particularly important it is highlighted with references to the type of technical personnel required to intervene.

All updates HABASIT considers necessary to improve the quality of the hot-pressing device will be communicated by way of sending further specific documentation or a new manual to replace the previous one.

If the hot-pressing device is sold to another customer, the manual must accompany the hot-pressing device and the new customer must be notified to HABASIT for any future modifications and updates.

A copy of this manual, delivered with the hot-pressing device, is meant for the maintenance operators, who shall read and keep it near the hot-pressing device, and consult it before undertaking any action on the hot-pressing device.



## **A.4 Guarantee conditions**

### **A.4.1 Guarantee terms and validity**

The manufacturer guarantees the product against any faults either in materials or in workmanship, for 1 (one) year from the date of installation of the product at the Buyer's premises. In this case, the manufacturer shall limit itself to replacing or repairing any part or parts returned to the manufacturer, which was/were found to be faulty.

The manufacturer may, at his own discretion, also replace or repair any part or parts of the product being repaired that is/are felt to be defective.

The manufacturer shall have the sole right to decide if such parts should be repaired or replaced.

The manufacturer shall not be liable in any other case for collateral or incidental damage.

The guarantee does not apply to plant that has been repaired by third parties that have NOT been authorized by the manufacturer.

Spare parts supplied by the manufacturer must be used. Any deviation from this rule will mean the guarantee will not apply.

### **A.4.2 When the guarantee can be voided**

The manufacturer's guarantee for the plant and associated equipment may be annulled as a result of improper intervention or repairs.

The manufacturer's guarantee for the equipment may be annulled as a result of the use of improper materials or materials not supplied by the manufacturer.

This manual's instructions must be observed or the guarantee cover will be lost.

## **IMPORTANT**

HABASIT CANNOT BE HELD RESPONSIBLE FOR ANY DAMAGE CAUSED BY IMPROPER, INCORRECT AND UNREASONABLE USE OF THE HOT-PRESSING DEVICE.



## **A.5 Visual signs**

### **ATTENTION**

Visual signs – indicator notices – are applied to the hot-pressing device. A knowledge of their meaning helps ensure that safety regulations are observed to prevent accidents and assure good operation. All people approaching the hot-pressing device must have a clear understanding of the symbol and its meaning. Non observance may cause accidents entailing damage to personnel and to the hot-pressing device.

### **A.5.1 Signs**

The signs affixed to the hot-pressing device are shown below. Such signs enable staff operating or working on the hot-pressing device to know about and so prevent the dangers and risks of not observing the principal safety rules.



TABLE 1 - DANGER SIGNS







	<p><b>Attention: DANGER OF ELECTRIC SHOCKS</b>          Indicates the personnel involved that, if the described operation is not performed while observing safety regulations, there is a risk of suffering an electric shock.</p>
	<p><b>Attention: DANGER OF CRUSHING OF OR INJURIES TO HANDS AND FINGERS</b>          Indicates the presence of materials which can cause damage to limbs.</p>
	<p><b>Attention: HIGH TEMPERATURE PARTS</b>          Indicates the presence of very hot materials which could cause burns.</p>

TABLE 2 - PRESCRIPTIVE SIGNS

	<p><b>General obligation</b>          An obligation to carry out the operation as described and in accordance with safety rules so as to avoid risks and accidents.          This is usually accompanied by notices explaining the obligation.</p>			
	<p><b>Obligation to use protective gloves</b>          Use of protective gloves by the operator, as the risk of hand injuries is implicit.</p>			
	<p><b>Obligation to use protective shoes</b>          Use of protective shoes by the operator as the risk of slipping, perforation or crushing of feet is implicit.</p>			
<table border="1" data-bbox="197 1630 462 1720"> <tr> <td><b>Vorsicht!</b> Nur geschlossene Presse unter Druck setzen (max 3 bar)</td> <td><b>Caution!</b> Pressurize only when press is closed (max 42 psi)</td> <td><b>Attention!</b> No matter sous pression que formée (max 3 bar)</td> </tr> </table>	<b>Vorsicht!</b> Nur geschlossene Presse unter Druck setzen (max 3 bar)	<b>Caution!</b> Pressurize only when press is closed (max 42 psi)	<b>Attention!</b> No matter sous pression que formée (max 3 bar)	<p><b>Maximum usable pressure warning</b>          Indication of maximum pressure that can be applied to the pressure cushion.</p>
<b>Vorsicht!</b> Nur geschlossene Presse unter Druck setzen (max 3 bar)	<b>Caution!</b> Pressurize only when press is closed (max 42 psi)	<b>Attention!</b> No matter sous pression que formée (max 3 bar)		

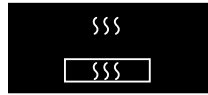

**TABLE 3 - TERMS AND DEFINITIONS**

TERM	DEFINITION
<b>PROTECTION DEVICES</b>	Safety measures involving the use of specific technical means called protection devices (guards, safety devices) to protect persons from dangers that cannot be reasonably eliminated or sufficiently reduced in the design of the machine.
<b>GUARD</b>	A part of the machine specifically used to provide protection by the use of a physical barrier. Depending on how it is made, a guard may be called a cowling, cover, screen, door or fence etc. Note 1 - A guard may act: - alone; in which case it is effective only when closed - associated with a locking device with or without locking the guard; in this case protection is assured whatever the position of the guard. Note 2 - «Closed» means, in the case of a fixed guard, «kept in position».
<b>FIXED GUARD</b>	Guard kept in position (i.e. closed), by means of a fastening (screws, bolts etc.) that make its removal/opening impossible without the use of tools.
<b>MOBILE GUARD</b>	Guard that is generally mechanically connected to the frame of the machine or to nearby fixed element (by means for example of hinges or guides), and that can be opened without the use of tools.
<b>INTERLOCKED MOBILE GUARD</b>	Guard associated with an interlock device so that : The machine's dangerous functions «protected» by the guard cannot be carried out unless the guard has been closed – If the guard is opened during the unfolding of the machine's dangerous functions, a stop command is given – The closure of the guard permits execution of the machine's dangerous functions «protected» by the guard but it does not control the start up.



<b>SAFETY DEVICE</b>	Eliminates or reduces the risk, either alone or in association with a guard.
<b>INTERLOCK DEVICE (INTERBLOCK)</b>	An mechanical or electrical or other kind of device whose aim is to prevent elements of the machine from functioning under specified conditions (generally until the guard is closed).
<b>PROTECTION STRUCTURE</b>	A physical obstacle such as a guard or part of the machine, that limits the movement of the body and/or one of its parts. The safety distances have been determined on the basis of the requisites at point 4.1.1 of the standard UNI EN294.
<b>SAFETY DISTANCE</b>	The minimum distance a protective structure must be positioned with respect to a dangerous area. The safety distances have been determined on the basis of the requisites at point 4.1.1 of the standard UNI EN294.
<b>INDIVIDUAL PROTECTION DEVICE</b>	Safety devices such as gloves, shoes, helmet, visor, earplugs etc. aimed at protecting parts of the body.
<b>CONTROL CIRCUIT</b>	A circuit used to control the working of the machine and protect the power circuits.
<b>CONTROL DEVICE</b>	A device inserted into a control circuit and used to control the working of the machine (e.g. position sensors, manual control switches, relays and electromagnetic valves).



## A.6 Safety warnings

When using industrial machines and systems, one should be aware that moving mechanical parts (linear or rotary movement), high voltage electrical parts, and any parts at high temperature, etc, can cause serious damage to persons and materials.



In designing and building the hot-pressing device, the Manufacturer focused special attention on safety in order to supply a SAFE hot-pressing device and, therefore, the Manufacturer has provided protective and safety devices considered necessary according to the Risk Analysis carried out by expert personnel. People in charge of system safety must make sure that the following essential safety regulations are observed:

	Do not run the hot-pressing device with the fixed and mobile protective devices dismantled or disabled.
	Do not run the hot-pressing device with the fixed and mobile protective devices dismantled or disabled. It is forbidden to switch off safety devices installed on the hot-pressing device or create by-pass systems to limit switches or micro-switches.
	Operations with reduced safety devices must be carried out strictly observing the instructions in the relevant descriptions, and must be performed by specialized technicians aware of the risk, under the direct supervision of the company person responsible for safety. Active protective devices must be restored as soon as possible, limiting this high risk status to the minimum.
OFF	Cleaning and maintenance operations must be performed with the electrical and pneumatic cut-out devices switched OFF. To this end, the hot-pressing device is provided with emergency push-buttons which shut down the system. It is good practice to use them as safety lock-outs to avoid accidental starting during inspections or mechanical jobs.
	Clean covers and control panel with soft, dry cloths lightly dampened in detergent; do not use solvents as they could damage the surfaces.
	Do not modify the hot-pressing device or its parts. Otherwise, the Manufacturer shall not hold itself responsible for damage to persons and materials. Request any modifications/customizing directly from the Manufacturer.

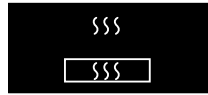

## **A.7 Remaining risks**

The use of the hot-pressing device during its operation may give risk to additional risks such as the following:

The possibility of crushing occurring during press closing.

The possibility of burns occurring in the pressing area if the temperature is not first checked or if suitably protective gloves are not worn.

The possibility of scalding or burning occurring by hot liquid or steam in the cooling circuit if the cooling cycle is incorrectly stopped without paying attention to the warnings given in this manual.

The possibility of contact between water and live equipment.

The user is responsible for taking care during transportation and movement of the equipment where the use of extraneous equipment (such as forklift trucks etc.) present dangers from bumping into and crushing persons in the area of these operations.



Ensure during equipping and maintenance operations that the stages in the chapters of the manual are scrupulously adhered to and have these operations carried out only by suitably prepared and qualified persons.



## A.8 Qualification of personnel

Each task must be assigned to a person trained in the work to be carried out and trained in correct usage as well as fully aware of any remaining risks and dangers in that work. Personnel must not carry out work outside their area of competence, knowledge and responsibility.

**TABLE 4 - QUALIFICATIONS**

	<p><b>FIRST LEVEL MACHINE CONTROL OPERATOR</b></p> <p>Indicates non qualified personnel i.e. without specific competencies and able only to carry out simple tasks, including in practice running the machine with the use of the controls on the push-button panel and loading and unloading materials used during production. Furthermore, this operator can work with the machine while the machine's protective devices are enabled, to carry out simple, ordinary jobs for adjusting, starting or re-starting production following enforced down-time.</p>
	<p><b>MECHANICAL MAINTENANCE PERSON</b></p> <p>A qualified technician able to run the machine under normal conditions, to intervene on mechanical parts to make all adjustments as well as the necessary mechanical maintenance and repair jobs, also with the protective devices disabled.</p>
	<p><b>ELECTRICAL MAINTENANCE PERSON</b></p> <p>A qualified technician able to run the machine under normal conditions, and also with the protective devices disabled; s/he is entrusted with all electrical jobs involving adjustment, maintenance and repairs. This operator is able to work while the interior of the cabinets and the connector blocks are electrically live.</p>
	<p><b>QUALIFIED TECHNICIAN</b></p> <p>A person who is by training, experience, education and knowledge of accident prevention regulations and procedures able to perceive and avoid possible dangers and who is authorized by the plant's safety officer to carry out all necessary mechanical and electrical intervention.</p>
	<p><b>SPECIALIZED SUPERVISOR</b></p> <p>An expert, specialized technician provided by the Manufacturer to carry out complex operations in particular situations, installation, first start-up, instruction of the Customer's personnel, as well as overhauls of and modifications to the machine.</p>



## **A.9 References and standards**

### **A.9.1 Applicable EU Directives**

EU Directive N° 98/37 of 23.07.98 known as the "Machines directive".

EU Directive N° 60/204 known as "Low tension directive"

EU Directive N° 89/336 for the convergence of Member State law on electromagnetic compatibility.

**Application of the above directives is formalized through the signing of the MANUFACTURER'S DECLARATION OF CONFORMITY drawn up once the inspection test has been carried out at the place of installation.**

This hot-pressing device has been constructed in a country that is part of the European Community and therefore meets the safety requirements of EU directive 98/37/CE, in force from July 23, 1998.

This conformity is certified and the hot-pressing device bears the CE mark of compliance (see figure).

### **A.9.2 EU Directives concerning safety in the workplace**

EU Directive N° 89/391 concerning the improvement of the safety and health of workers during work, in addition to the following particular directives EU N° 89/654 and N° 89/655.

EU Directives N° 77/576 and N° 79/640 concerning safety signs in the workplace.

### **A.9.3 EU Directives concerning personal protection**

EU Directive N° 89/656 and N° 89/686 concerning the use of personal protection devices.

### **A.9.4 EU Directives concerning environmental protection**

EU Directives N° 75/442 on the disposal of waste.

EU Directives N° 78/319 on the disposal of toxical and harmful waste.



## **B. TECHNICAL SPECIFICATIONS**



### B.1 Purpose of the hot-pressing device

The hot press PM-2006 has been specifically developed for joining of HABASIT power transmission and conveyor belts and machine tapes using the Thermofix and Flexproof process.

The Thermofix process includes all the flat belts and other Habasis conveyor belts with right-angled or oblique-angled joints (for width and thickness details see: [TECHNICAL CHARACTERISTICS OF THE HOT-PRESSING DEVICE](#)).

The Flexproof process includes most of the Food and Standard conveyor belts from Habasis as well as the thermoplastic transmission belts (for width and thickness see: [TECHNICAL CHARACTERISTICS OF THE HOT-PRESSING DEVICE](#))

Further details about these processes can be obtained at:

For the **Thermofix** process (see technical manual Thermofix).

For the **Flexproof** process (see technical manual Flexproof).

#### NOTE

*By connecting to the company's IT net H/Net it is possible to access current valid process data.*

The hot press PM-2006 has been developed exclusively for the applications described herein. No other or inappropriate applications are permitted.

#### ATTENTION

ANY USE OF THE HOT-PRESSING DEVICE OTHER THAN FOR WHICH IT WAS DESIGNED MAY BE IMPROPER USE AND RESULT IN NOT BEING SAFE FROM THE POINTS OF VIEW OF THE OPERATOR, MAINTENANCE WORKER AND OF THE HOT-PRESSING DEVICE ITSELF. HABASIT SHALL NOT BE HELD LIABLE FOR THE CONSEQUENCES OF ANY BREACHES OF THESE RULES.

#### IMPORTANT

All assembly, maintenance and repair work, as well as the operation of the equipment, is expected to be carried out by qualified personnel or staff under the supervision of responsible specialists and experts. In case of doubt or lack of detailed information, always contact the manufacturer (see [HOW THE MANUAL IS ORGANIZED](#)).



Author: S.D.T. / KM  
Edition: 02/2005  
Replaces: 01/2002

### B.2 Press identification data

A plate fitted to the structure of the hot-pressing device indicates the device's identification data. These data are shown in the following figure.

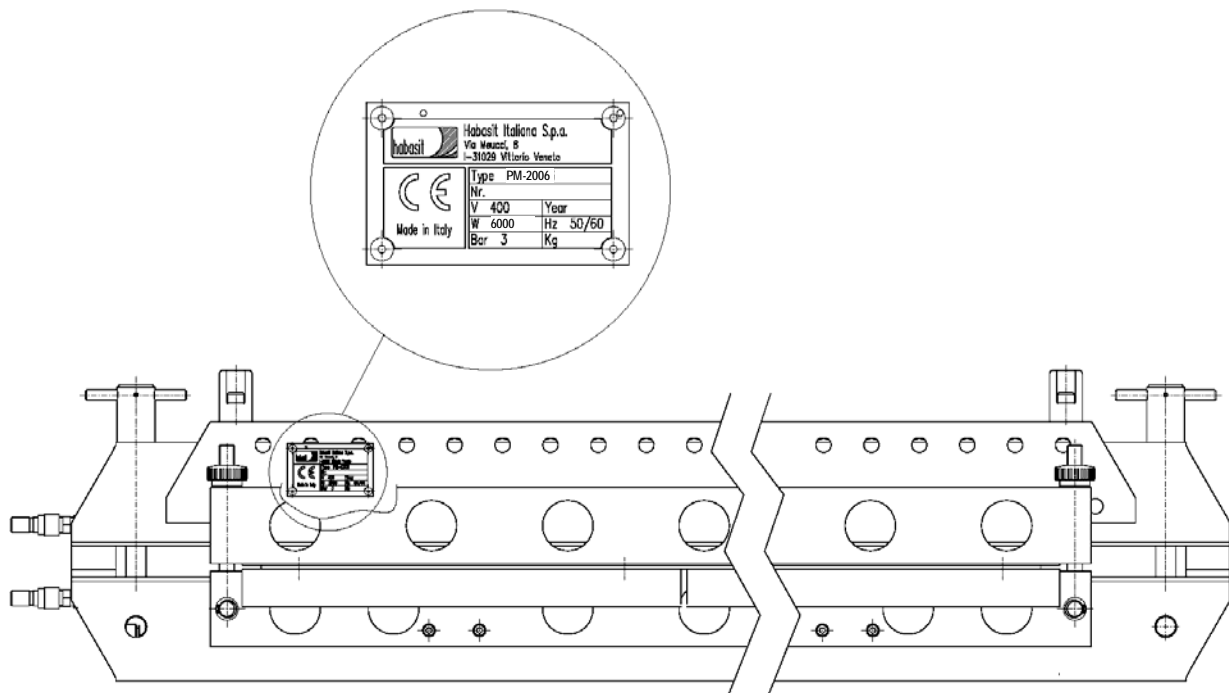

FIGURE 1 - MACHINE IDENTIFICATION PLATE



### B.3 Technical characteristics of the hot-pressing device

TABLE 5 - ELECTRICAL CHARACTERISTICS OF THE HEATERS

Output	3000 W x 2 = 6000 W
Supply tension	380 V~
Frequency	50-60 Hz
Our code	IN040366

Output	3000 W x 2 = 6000 W
Supply tension	220 V~
Frequency	50-60 Hz
Our code	IN040359

TABLE 6 - PNEUMATIC CHARACTERISTICS

Fluid characteristics	Filtered, non-lubricated air
Working pressure	6 bar +/- 0.2 bar
Min. supply diameter	Quick coupler of ¼"

TABLE 7 - WATER CHARACTERISTICS

Fluid characteristics	Demineralized water
Capacity	5 m <sup>3</sup> /h (*)
Working temperature	From 10 °C to 35 °C
Min. supply diameter	Quick coupler of ¼"

(\*) mobile pump capacity



**TABLE 8 - DIMENSIONS AND ENVIRONMENTAL CHARACTERISTICS**

Dimensions(Length x Width x Height) (including handles)	2360 + 250 x 320 x 336 mm <i>92.9 + 10 x 12.8 x 13.2 inch</i>
Total Weight	230 kg / 507 lbs
Upper part weight	89 kg / 196.2 lbs
Lower part weight	89 kg / 196.2 lbs
Steel stabilizers weight	39 kg / 86 lbs
Noise level	<70 db
Working temperature	Between 15 °C – 38 °C
Humidity tolerance	Between 45 – 70%

**TABLE 9 - CHARACTERISTICS OF WORKABLE ELEMENTS**

Max width of belt	2000 mm / 80 in.
Max thickness of belt	10 mm / 0.4 in.
Minimum length of belt	850 mm / 33.5 in.
Heating plate width	100 mm / 4 in.
Maximum presser pressure	3 bar / 43.5 psi
Max. working temperature	199 °C / 390 °F
Temperature interval	+ 2°/- 4 °C + 3.6° / - 7.2 °F
Maximum heating plate temperature deviation from nominal value	+/- 2 °C / 3.6 °F
Mean heating time at 180 °C	14 min (230V~); 15 min (400V~)
Cooling time from 180 °C to 80 °C (with water at room temperature)	2:30 min



## B.4 Equipment and accessories provided

The following are the necessary accessories for stationary and mobile use

### B.4.1 Necessary accessories for stationary use

TABLE 10 - NECESSARY ACCESSORIES FOR STATIONARY USE

Code Assembly	Part code	Description	Q.ty
691730		HOT PRESS PM-2006/100 400V	1
		OPERATING INSTRUCTION PM (SERIE 6) (PM-xx06)	1
691011		CABLE CONNECTION PAIR REGULATOR PMR-04/PMR-06 AND OUTLET PM.	1
20501000		MATERIAL PROVIDED	1
	IN020410	PLASTIC TUBE PVC 6x12 cod. TA06	5 m.
	IN020411	TUBE CLAMP 14x24 MINUSSGM	12
	IN020412	COLLAR WITH TWO EARS COL-PI 11x13	3
	IN020413	FEMALE COUPLING 1/4" cod. 403 1/4SV (RAPID FIT)	4
	IN020371	HOSE-END FITTING 12x1/4" CH 17	4
	IN020407	HOSE-END FITTING 6x1/4" Code1.13234	1
	IN020429	MANITOBA TUBE D.10x21mm 170° L=20ml	1
	IN010146	COPPER WASHER 1/4"	4
	IN020655	FEMALE COUPLING 04 MINI 1/4" cod.01010004	1
		REGULATING UNIT PMR-XX - The regulating unit varies according to working tension. The regulating unit is thus determined by the working tension of the press it is combined with	1
691000		PMR-04 3x230V 4 RES x 4000W	
691001		PMR-04 3x400V 4 RES x 4000W	
691020		PMR-06 3x230V	
691021		PMR-06 3x400V	
		COOLING UNIT PMC-XX - The control unit may vary according to the regulating unit (PMR-XX) used	1
691010		PMC-04	
691060		PMC-06	

For the selection of regulating unit PMR-XX and control unit PMC-XX see [B.4.3 Regulating unit options](#).  
 For the selection of control unit PMC-XX see [B.4.4 Cooling unit options](#)



#### B.4.2 Necessary accessories for mobile use

The following are indications for the necessary accessories for mobile use.

TABLE 11 - ACCESSORIES NECESSARY FOR MOBILE USE

Assembly code	Part code	Description	Q.ty
691730		HOT PRESS PM-2006/100 400V	1
		OPERATING INSTRUCTION PM (SERIE 6) (PM-xx06)	1
691011		CABLE CONNECTION PAIR REGULATOR PMR-04/PMR-06 AND OUTLET PM.	1
		REGULATING UNIT PMR-XX. - The regulating unit varies according to working tension. The regulating unit is thus determined by the working tension of the press it is combined with	1
691000		PMR-04 3x230V 4 RES x 4000W	
691001		PMR-04 3x400V 4 RES x 4000W	
691020		PMR-06	
691021		PMR-06	
		MOBILE COOLING PUMP - The cooling pump varies according to the available electrical power.	1
691016		MOBILE COOLING PUMP PM-04/7 230V	
691015		MOBILE COOLING PUMP PM-04/6 120V	
		MOBILE MINI COMPRESSOR - The compressor may vary according to the electrical tension available	1
691017		MOBILE MINI COMPRESSOR MC-04/7 230V	
691018		MOBILE MINI COMPRESSOR MC-04/6 120V	
N-26964		Adaptor for direct PMR-06 connection (only for 230V)	

For selection of the regulating unit PMR-XX see [B.4.3 Regulating unit options.](#)



### B.4.3 Regulating unit options

The following are indications of the combinations of possible use between joining presses and PMR-XX regulating units.

TABLE 12 - REGULATING UNIT OPTIONS (PMR-XX) (PRESS-XX COMBINATIONS)

	PM-305	PM-306	PM-606	PM-806	PM-1056	PM-1306	PM-1606	PM-2006	PM-804	PM-1604	PM-2404	PM-3204	PM-3604	PM-4204	Code
PMR-305 1x120V 360W	X														691301
PMR-305 1x230V 400W	X														691302
PMR-305 RC06 1x120V 3600W		X	X												691306
PMR-305 RC06 1x230V 3600W		X	X	X	X				X						691307
PMR-04 3x230V 4 RES x 4000W		X	X	X	X	X	X	X	X	X	X	X	X	X	691000
PMR-04 3x400V 4 RES x 4000W		X	X	X	X	X	X	X	X	X	X	X	X	X	691001
PMR-06 3x230V		X	X	X	X	X	X	X	X	X	X	X	X	X	691020
PMR-06 3x400V		X	X	X	X	X	X	X	X	X	X	X	X	X	691021

### B.4.4 Cooling unit options

The following are indications of the combinations of possible use between PMC-XX control units and regulating units PMR-XX.

TABLE 13 - CONTROL UNIT OPTIONS (PMC-XX) (PMR-XX – PMC-XX COMBINATIONS)

	PMR-04	PMR-06	Code
PMC-04 (1x230V)	X	X	691010
PMC-06		X	691060



#### B.4.5 Optional accessories for both stationary and mobile use

The following are indications for the optional accessories both for stationary or variable use situations.

TABLE 14 - OPTIONAL ACCESSORIES (FOR BOTH STATIONARY AND MOBILE USE)

Description	Code
Pair of gloves	N-29090
Thermometer	N-28714 or N-28715
Silicone paper, matt	N-28638
Silicone paper, structured	N-28637
Various embossing media, ask our specialists	
Molleton	N-28665



## **B.5 Ordering of accessories and spare parts**

### **IMPORTANT**

To order accessories or spare parts, please do the following:

- Quote the name of the hot-pressing device.
- Quote the position of the part.
- Quote the description of the part.
- Quote the technical code.

When making your request, briefly illustrate the causes of failure of the part being ordered, and provide all information which may be useful for understanding the malfunction. This will make it possible to pinpoint any shortcomings or incorrect procedures which may have caused the damage.

When ordering spare parts, we recommend using the fax and not just placing your order by phone.

**Habasis Italiana S.p.A.**  
**Via A. Meucci 8**  
**Zona Industriale**  
**I - 31029 Vittorio Veneto**  
**Tel.: 0039. (0) 438.9113**  
**Fax: 0039.438.200545**

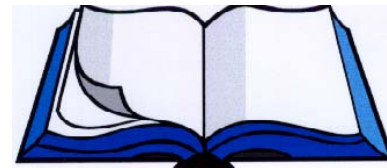

The parts marked P and N are available at the headquarters of Habasis Reinach, Switzerland.

Habasis Italiana S.p.A.  
Vittorio Veneto 31029 (TV)  
Tel.: ++39(0)438.9113  
Fax. ++39(0)438.200545



## Hot Press PM-2006



---

Author: S.D.T. / KM  
Edition: 02/2005  
Replaces: 01/2002

**INSTALLATION**  
Page C-1

---

### C.           INSTALLATION

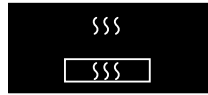

## C.1 Preparation of working area

### ATTENTION

The hot-pressing device must be placed on a floor or support of suitable size that is able to take the weight and bulk of the equipment.

The machinery must be placed in a room with sufficient lighting, avoiding dazzling and stroboscopic effects. Personnel entrusted to control the hot-pressing device must be able to work under normal light conditions (usually provided by neon lights fitted on the ceiling). If the lighting level is insufficient, the Customer must provide an additional lighting system since the machinery is not supplied with its own lighting system for the operational zone.

The work area must be well ventilated and/or have an air cycling and emission system compliant with the law of the country of installation, such as to ensure the operator is working under the proper working conditions.

The free space around the machine must be sufficient for work and maintenance operations and permit access all workstations taking account of the size of the pieces to be worked on.

The Customer must provide all the sources of energy required for electrical power and compressed air as indicated in [TECHNICAL CHARACTERISTICS OF THE HOT-PRESSING DEVICE](#).

Ensure there is sufficient operational space around the press.

Make sure that there is a properly stocked first aid box on site nearby.

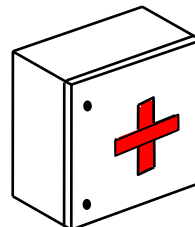

### ATTENTION

The main switch of the electrical panel must be in its «OFF» position when the hot-pressing device is being connected up.



## **C.2 Packing and handling**

### **ATTENTION**

#### **C.2.1 Handling – Stationary use**

The movement of the packaging and machinery should be carried out by authorized operators. Suitable equipment must be used to move the hot-pressing device, with adequate strength to deal with the weight and bulk of the hot-pressing device.

When unpacking, check that no small parts remain in the case, and carefully check the general conditions.

In transit, or on being moved, the hot-pressing device must be disconnected from any control or regulating units.

There are two handles at the side of the hot-pressing device for lifting the equipment. The fastening rods at each end of the hot-pressing device must be evenly locked before hoisting.

Never use any hooking points other than the specific (3) eye-bolts when hoisting the hot-pressing device. The fastening rods (4) must be correctly closed.

Concerning disposal of packing materials, the user must observe the current laws of the country of installation.

### **IMPORTANT**

REPORT ANY DAMAGE NOTED ON THE HOT-PRESSING DEVICE AT DELIVERY TO THE CARRIER AND SUPPLIER.

Packing materials (wood, nails, plastic, barrier bags, etc.) can be sources of danger and should be placed in collection points, especially if polluted or non-biodegradable.

The user must observe the waste disposal legislation in the country of installation when disposing of the packaging.

### **ATTENTION**

ALL HANDLING OPERATIONS OF THE HOT-PRESSING DEVICE MUST BE PERFORMED SLOWLY WITHOUT ANY SUDDEN MOVEMENTS, TO AVOID TO DAMAGE PERSONS AND MATERIALS.



## **C.2.2 Handling – Mobile use**

**To make transportation of the hot-pressing device easier it can be dismantled as indicated:**

If connected, disconnect the various electrical, water and air connections.

Disassemble the upper part of the press (1) (the support with the heating element).

Disassemble the lower part of the press (6) (the support with heating element).

Disassemble the heat equalizing plate with clamping device (8).

Use suitable handling and transport equipment capable of dealing with the object's weight, while taking care during the transportation itself.

Reassemble the hot-pressing device and ensure that its mechanical parts are functioning properly.

Reconnect the power while taking special care when handling electrical power sources close to the water used in the cooling system.

**The hot-pressing device can also be moved as a single unit, in which case the following must be carried out:**

If connected, disconnect the various electrical, water and air connections.

Use transportation equipment of the correct capacity for the weight of the object to be moved.

Verify that the hot-pressing device and all its mechanical parts have not been damaged in transit and that all are working correctly.

Reconnect the power while taking special care when handling electrical power sources close to the water used in the cooling system.

### **ATTENTION**

ALL OPERATIONS MUST BE PERFORMED BY PROPERLY TRAINED AND EXPERT PERSONNEL.

### **ATTENTION**

ALL HANDLING OPERATIONS OF THE HOT-PRESSING DEVICE MUST BE PERFORMED SLOWLY WITHOUT ANY SUDDEN MOVEMENTS, TO AVOID TO DAMAGE PERSONS AND MATERIALS.

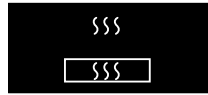

## **C.3 Assembling and installation**

### **Preliminary check**

Carry out a visual check on the device's appearance and on any accompanying equipment to see if there are signs of damage or breakage that may have occurred in transit. If such damage and/or failures are noted, contact HABASIT immediately. We advise you to also produce photographic evidence of the damage.

### **C.3.1 Positioning**

#### **IMPORTANT**

This operation requires the involvement of a **QUALIFIED TECHNICIAN** able to carry out and check correct positioning in observance of current safety regulations:

Make sure there is sufficient operational space for working on the press.

Position the press so that it is stable.

Check visually to make sure that no rags, work tools, etc remain on the hot-pressing device.

### **C.3.2 Connection of air and water supplies**

#### **ATTENTION**

The hot-pressing device can be used in Stationary operation mode (permanently connected to control and regulation equipment) or in Mobile operation (when it is necessary to carry out work away from the usual site).

#### **Stationary operation**

Ensure that the whole system is not supplied by electrical, air and water sources.

Ensure all the plant providing the equipment corresponds with its own specifications.

Use the pneumatic connection kit (code 008E1000), to connect the pressure cushions of the upper and lower press parts.

The water and air power sources' output is handled by the cooling unit **PMC-XX**. Referring to Section B.4.4 [Cooling unit options](#) ensure that the cooling unit suits to the press and regulating unit used.



Make the necessary water connections between the cooling unit **PMC-XX** and the joining press.  
Make the necessary water and air connections between the water supply and the cooling unit **PMC-XX**.  
Ensure the water connections are well sealed and that any leaks that could occur do not come into contact with electrical parts.

### **Mobile operation**

Running the system in its mobile operation requires the use of suitable equipment (such as a portable compressor for the air supply and a water tank with immersion pump or available running water).  
Ensure that the whole system is not supplied by electrical, air and water sources.  
Ensure all the plant providing the equipment corresponds with its own specifications.  
Use the pneumatic connection kit (code 008E1000), to connect the pressure cushions of the upper and lower press parts.  
Ensure the water connections are well sealed and that any leaks that could occur do not come into contact with electrical parts.

### **C.3.3 Electrical connection**

#### **ATTENTION**

Ensure that the whole system is not supplied by electrical, air and water sources.  
Ensure all the plant providing the equipment corresponds with its own specifications.  
The electrical power parts (and water and air supply logic systems) are managed by the regulating unit **PMR-XX**. Referring to [Section B.4.3 Regulating unit options](#) ensure the regulating unit is suitable for the hot-pressing device actually used.  
Connect the hot-pressing device's connectors to the regulating unit **PMR-XX**.  
If present carry out the necessary connections between the regulating unit **PMR-XX** and the cooling unit **PMC-XX**.  
Connect the regulating unit **PMR-XX** to the mains electrical supply (see manual **PMR-XX**).

#### **NOTE**

*The use of a regulating unit is necessary both for stationary operation and for mobile operation.*



## C.4 Disassembling of the hot-pressing device

Hot-pressing device dismantling operations must be performed by:

Technicians of HABASIT Assistance Service.

Technicians authorized by HABASIT, with experience of: Machine assembly/disassembly.

Assembly/disassembly of the electrical, pneumatic and hydraulic plant, consulting the corresponding diagrams.

### ATTENTION

BEFORE CARRYING OUT ANY KIND OF WORK ON THE HOT-PRESSING DEVICE IT IS ESSENTIAL TO ENSURE THAT THE SYSTEMS (ELECTRICAL, PNEUMATIC AND WATER) ARE DISCONNECTED FROM ENERGY SUPPLIES, THAT PNEUMATIC AND WATER IS PROPERLY DEPRESSURISED AND THAT THERE IS NO REMAINING POTENTIAL ENERGY IN THE MOVING PARTS.

### ATTENTION

Follow the following disconnection procedure:

Disconnect the electrical circuit.

Disconnect the water circuit.

Disconnect the air circuit.

Carry out mechanical disassembly.

If the hot-pressing device has to be stored for a certain time, prepare it as indicated in the next section, but if it has to be handled immediately, refer to the appropriate section.



## C.5 Storage

### IMPORTANT

The hot-pressing device must be stored in a dry room free from seepage of liquids.

### NOTE

*Never, on any account, store the hot-pressing device out of doors! As a general rule, observe the following environmental conditions.*

**TABLE 15 - STORAGE CONDITIONS**

	<b>Environmental conditions for storage</b>
Min/Max ambient temperature of storage	In the range of +5 °C to +40 °C
Relative humidity of place of storage	In the range of 50% to 70%

If the hot-pressing device, its accessories and spares have to remain in storage for a prolonged period, they must be protected from dust and damp.

### **We recommend the following:**

Clean the hot-pressing device in general.

Apply PROTECTIVE SILICONE OIL to **un**-painted or **un**-treated parts.

Cover the hot-pressing device with a sheet to protect it from dust.

Before being oiled or greased for good preservation, some parts can, if necessary, be cleaned with a specific, rustproofing detergent.



## C.6 Disposal

### **IMPORTANT**

The hot-pressing device PM-2006 is built with different types of material. When they have reached the end of their useful life, such materials must be disposed of at specialized centers, according to the prescriptions of the laws in force in the country of destination.

### **ATTENTION**

The materials and substances making up the hot-pressing device **MUST** be eliminated according to the Laws/Regulations on disposal of individual waste in force in the country where the hot-pressing device is installed.

IN ANY EVENT, NO COMPONENT OF THE HOT-PRESSING DEVICE MUST BE LEFT IN THE ENVIRONMENT.

CONTACT AN AUTHORIZED COMPANY TO CARRY OUT THIS TYPE OF OPERATION.

Habasis Italiana S.p.A.  
Vittorio Veneto 31029 (TV)  
Tel.: ++39(0)438.9113  
Fax. ++39(0)438.200545



## Hot Press PM-2006



---

Author: S.D.T. / KM  
Edition: 02/2005  
Replaces: 01/2002

**OPERATION**  
Page D-1

---

### D. OPERATION



## D.1 General warnings

The operator and/or the maintenance person has the following responsibilities:

To create on and around the hot-pressing device the necessary conditions so that the installed protective devices are operational and efficient, as their purpose is to protect the personnel.

To observe the safety regulations described in the use and maintenance manual.

### **IMPORTANT**

THE INFORMATION DEVICES (SIGNS) AND SAFETY NOTICES MUST BE KEPT CLEAN AND LEGIBLE.

### **ATTENTION**

DO NOT IN ANY WAY ALTER THE SAFETY SYSTEM.

### **ATTENTION**

IT IS ABSOLUTELY FORBIDDEN TO REMOVE THE PROTECTIVE DEVICES INSTALLED.

### **ATTENTION**

CARRYING OUT CLEANING AND MAINTENANCE JOBS WHILE THE SYSTEMS ARE LIVE OR UNDER PRESSURE IS ABSOLUTELY FORBIDDEN.

### **ATTENTION**

DO NOT REMOVE THE GUARDS WHICH REQUIRE TOOLS FOR THEIR REMOVAL.



## **D.2 Guards installed**

### **IMPORTANT**

The hot-pressing device has a sheet steel guard with holes to prevent the operator coming into contact with hot parts.

### **ATTENTION**

READ THE ACCIDENT PREVENTION SIGNS WITH CARE, DO NOT COVER THEM FOR ANY REASON AND REPLACE THEM IMMEDIATELY IF THEY GET DAMAGED.

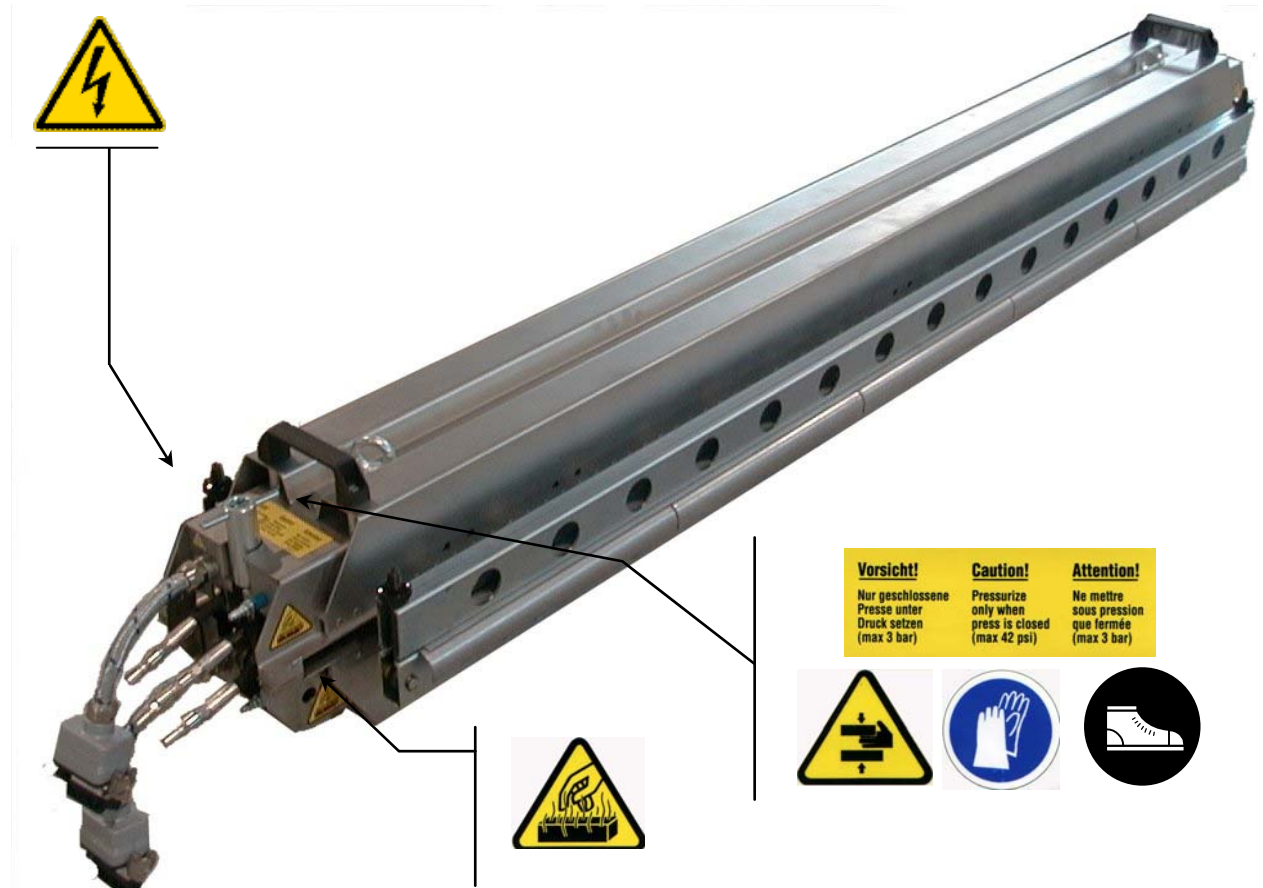
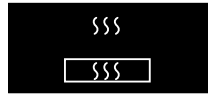

FIGURE 2 - POSITION OF SIGNS ON THE PRESS



## D.3 Identification of press' parts

### D.3.1 View of PM-2006

- 1) Upper part of press
- 2) Connection for pressure cushion
- 3) Eye bolt (for hoisting)
- 4) Locking spindle
- 5) Water-hose coupling
- 6) Lower part of press
- 7) Heating plate
- 8) Heat equalizing plate with clamping device

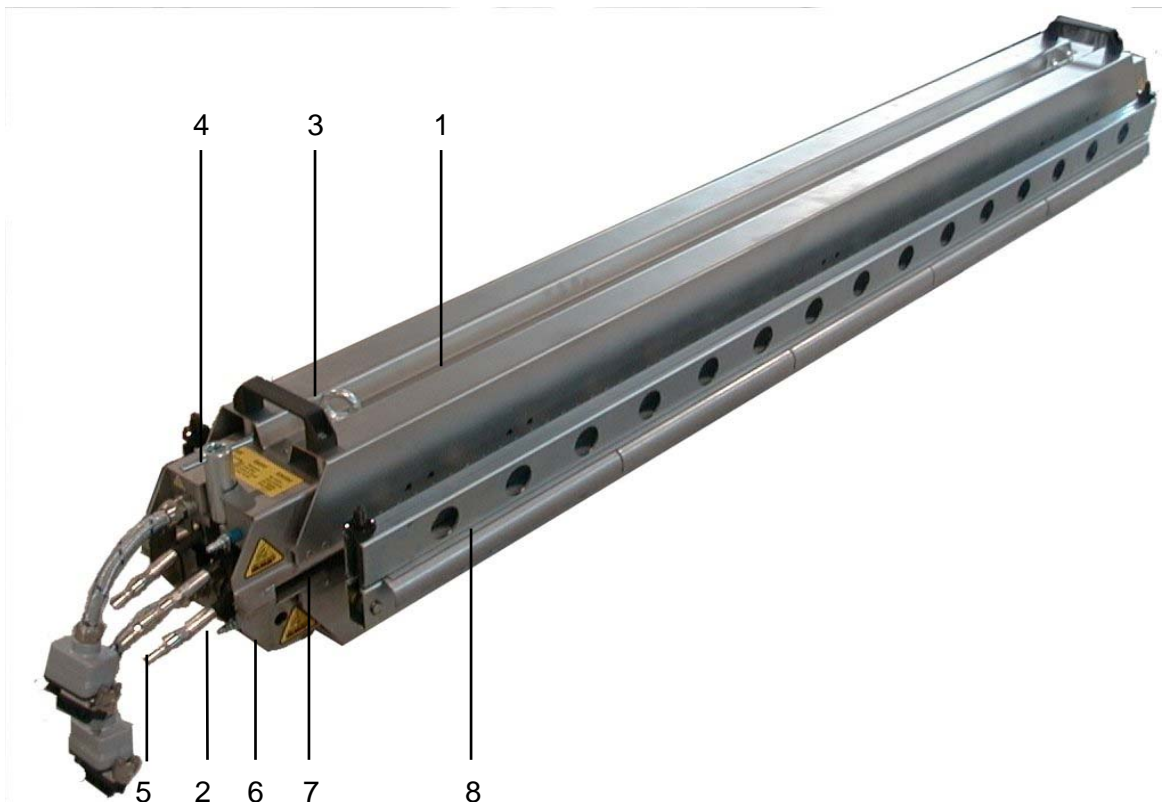
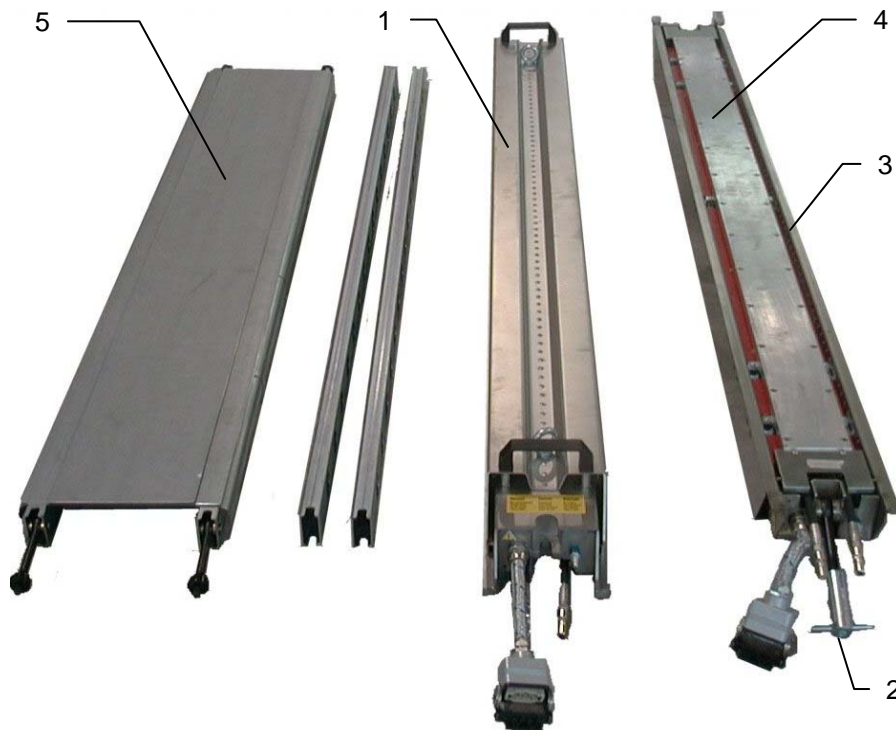

FIGURE 3 - VIEW OF PM-2006



### D.3.2 Main elements of the PM-2006

- 1) Upper part of press
- 2) Locking spindle
- 3) Lower part of press
- 4) Heating plate
- 5) Heat equalizing plate with clamping device



**FIGURE 4 - MAIN ELEMENTS OF THE PM-2006**



### D.3.3 Pneumatic connection



**FIGURE 5 - PNEUMATIC CONNECTION**





Stationary operation use with PMR-06 and PMC-06

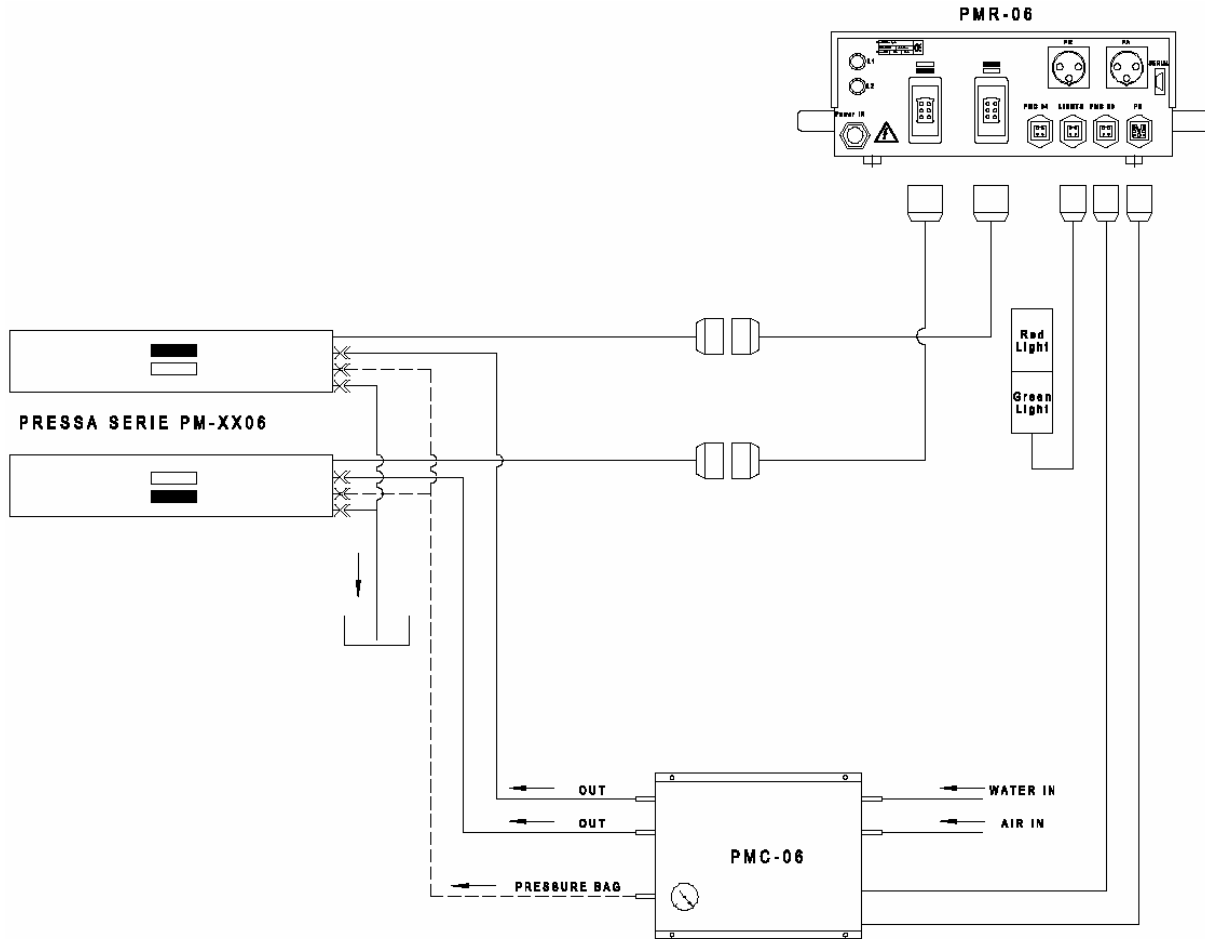

FIGURE 7 - STATIONARY OPERATION USE WITH PMR-06 AND PMC-06



## D.4.2 Mobile operation use

### Mobile operation use with PMR-06

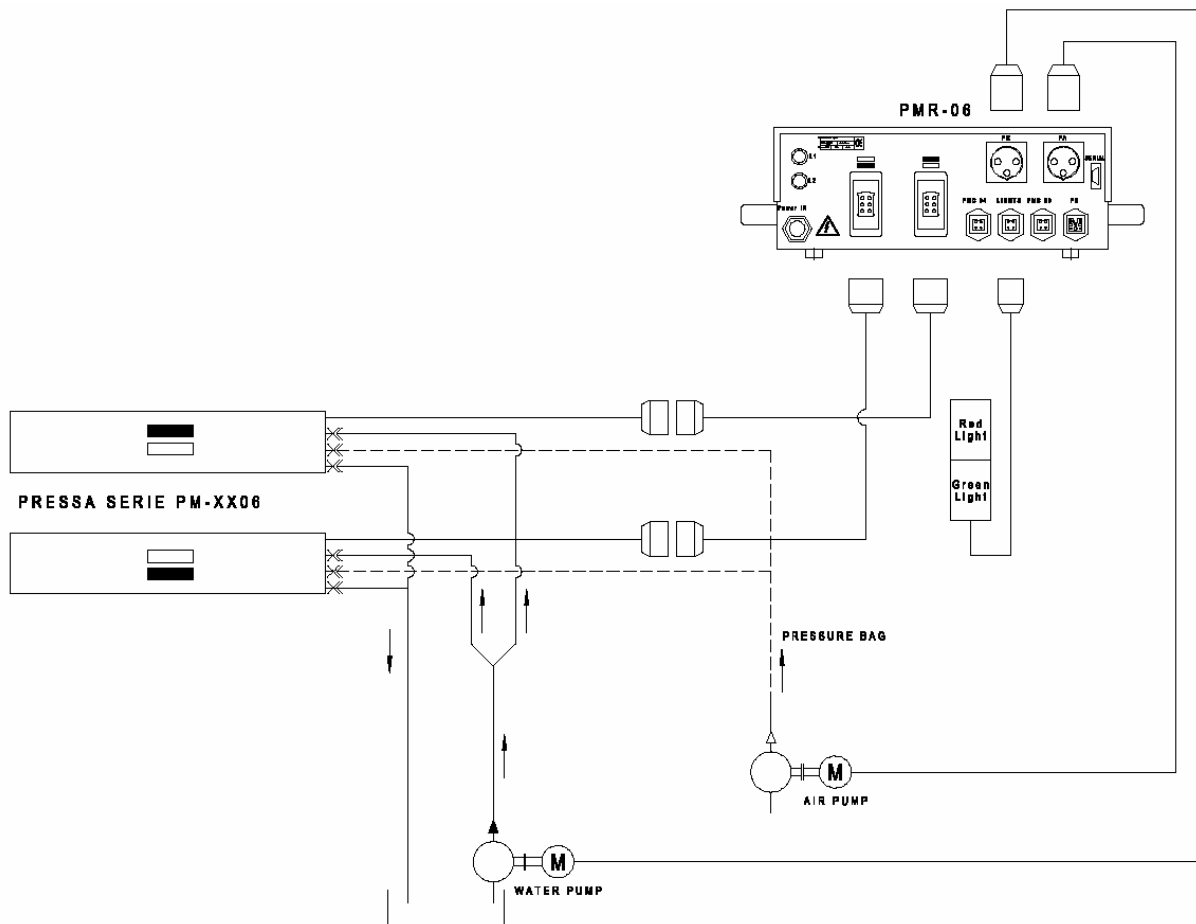

FIGURE 8 - MOBILE OPERATION USE WITH PMR-06



## **D.5 Press operation**

### **D.5.1 Working stationary and mobile**

#### **Stationary operation**

Where the hot-pressing device is permanently positioned with available supplies of electricity, compressed air and water. For its operation the hot-pressing device is managed by the following:

A regulating unit PMR-XX, which controls the temperature rising and a cooling unit PMC-XX. The cooling unit PMC-XX guides the water circulation in the cooling system and subsequently empties the circuit as well as inflating and deflating the pressure cushion (upper and lower).

#### **Mobile operation**

Where the hot-pressing device is not permanently positioned and is outside its normal working site. To be able to work without the normal equipment available, the hot-pressing device requires:

A regulating unit PMR-XX that guides the rise in temperature.  
The availability of running water or a tank with immersion pump working in manual mode.  
A portable manual mode air compressor.

### **D.5.2 Working cycles**

The hot-pressing device's working cycles are as follows.

This manual describes the hot-pressing device only. For the use of the regulating unit (PMR-XX) and the cooling unit (PMC-XX) see their own manuals.

### **D.5.3 Stationary operation use**

Check the working procedures for the belt/tape, check technical guidelines of the joining method and the individual Joining Data Sheet of the product.

Open the two locking spindels (4), flip them downwards and lift the upper part of the press (1). When opening the rods make sure not to put them down heavily on the floor or supporting surface.



Position the belt as required on the heat equalizing plate (8) and clamp it, making sure it is flat. Position the upper part of the press (1) onto the lower part of the press (6) with the belt fastened to the heat equalizing plate (8) and the required inserts. Flip back the two locking spindles (4) and evenly lock them at the two ends of the press. Ensure there is no liquid in the cooling circuit. This happens when the normal joining cycle is stopped (either deliberately or due to a black-out for example) during the cooling stage.

**In this case it is necessary to act as follows:**

Disconnect all electrical supply.  
Disconnect the tubes of the press.  
Empty the cooling circuit using jets of compressed air.  
When blowing air to expel water from the circuit, make sure the water does not come into contact with electrical equipment.  
Use the regulation unit PMR-XX (see its own manual) to bring the pressure cushion up to the desired pressure.  
Use the regulating unit PMR-XX (see its own manual) to preselect the hot-pressing device's upper and lower temperatures.  
Use the regulating unit PMR-XX (see its own manual) to select the joining time.  
Use the regulating unit PMR-XX (see its own manual) to start the joining cycle.  
When the joining cycle is completed the cooling cycle is started.  
Wait for the end of the cooling cycle.  
Tap water is used for cooling. In a stationary installation water softening is recommended. Detailed consulting is available on request.

**NOTE**

*If the cooling cycle is stopped before the end the circuit, it will not discharge all the water of the system. This may jeopardize the next joining cycle with resulting defective joints.*

**ATTENTION**

**The heated water can produce steam at 180° at a pressure of about 10 bar.**

After the joining and subsequent cooling, by using the regulating equipment PMR-XX (see its own manual), with the manual valve you can discharge the pressure of the pressure cushion. Where standard production series are being carried out, do not lower the temperature below 80°C to reduce the heating time required for the next working cycle. Open hot-pressing device, carefully take out the belt and allow it to cool at room temperature.

**ATTENTION**

**When you take the belt out, the press's parts are hot. Use suitable protective GLOVES.**



#### **D.5.4 Mobile operation use**

Check the working procedures for the belt/tape, check technical guidelines of the joining method and the individual Joining Data Sheet of the product.

Open the two locking spindels (4), flip them downwards and lift the upper part of the press (1). When opening the rods make sure not to put them down heavily on the floor or supporting surface.

Position the belt as required on the heat equalizing plate (8) and clamp it, making sure it is flat.

Position the upper part of the press (1) onto the lower part of the press (6) with the belt fastened to the heat equalizing plate (8) and the required inserts.

Flip back the two locking spindles (4) and evenly lock them at the two ends of the press.

Ensure there is no liquid in the cooling circuit. This happens when the normal joining cycle is stopped (either deliberately or due to a black-out for example) during the cooling stage.

#### **In this case it is necessary to act as follows:**

Disconnect all electrical supply.

Disconnect the tubes of the press.

Empty the cooling circuit using jets of compressed air.

When blowing air to expel water from the circuit, make sure the water does not come into contact with electrical equipment.

Use the portable compressor MC-04/x to bring the pressure cushion to the desired pressure.

Use the regulating unit PMR-XX (see its own manual) to preselect the hot-pressing device's upper and lower temperatures.

Use the regulating unit PMR-XX (see its own manual) to select the joining time.

Use the regulating unit PMR-XX (see its own manual) to start the joining cycle.

At the end of the joining cycle (see control equipment manual), it is necessary to manage the cooling of the hot-pressing device manually.

For this purpose connect the flexible water hose for the mobile cooler PM-04/x to the water-hose coupling (5) of the hot-pressing device and then start the electric pump (see 1.3.1 [Necessary accessories for mobile use](#)).

Wait for the end of the set cooling cycle.

Empty the air out of the pressure cushions.

Open hot-pressing device, carefully take out the belt and allow it to cool at room temperature.



### **ATTENTION**

**When you take the belt out, the hot-pressing device's parts are hot. Use suitable protective GLOVES.**  
**Remove water from the cooling circuit with jets of compressed air, ensuring it is completely emptied.**

### **NOTE**

*If not all the water is removed from the cooling circuit this may jeopardize the next joining cycle with resulting defective joints.*

### **ATTENTION**

**The heated water can produce steam at 180° at a pressure of about 10 bar.**

For rapid heating without energy wastage, heat up the hot-pressing device always closed.

## **D.5.5 Notes on use**

### **ATTENTION**

Never put the pressure cushion under pressure if the hot-pressing device is not properly closed. Do not exceed the maximum permitted pressure of 3 bar.

## **D.5.6 Technical assistance**

Our experts will be available for you to consult on the use of the hot-pressing device. If you have any technical queries regarding the operation and the status of the joining device, contact the manufacturer (see address in [How the manual is organized](#))



## D.6 Troubleshooting

### ATTENTION

Maintenance, repairs and replacement operations for electrical components must be carried out by an ELECTRICAL MAINTENANCE TECHNICIAN or a QUALIFIED TECHNICIAN able to perform the tasks in accordance with safety regulations.

TABLE 16 - TROUBLESHOOTING

Faults	Solutions
No air	Check for air in the supply line.
No current	Check that the main switch is in "ON" position.
Fault in temperature rise (Probable presence of liquid in the cooling circuit)	<ul style="list-style-type: none"> <li>- Disconnect all electrical supply.</li> <li>- Disconnect the tubes that bring water into the hot-pressing device.</li> <li>- Empty the cooling circuit using jets of compressed air.</li> </ul> <p><b>ATTENTION</b> - When expelling water with compressed air, make sure no water comes into contact with any of the electrical equipment.</p>
Temperature deviation of a heating plate of more than 2 °C with respect to the nominal value	<p>Exchange the two connectors in the rear part of the regulating unit and check whether the regulator always indicates the same anomalous value.</p> <p>In this case the fault can clearly be traced to the regulator in question.</p> <p>If the defect should pass to the other regulator, the fault can be attributed to the corresponding heating plate (7) or the thermocouple signal wire.</p> <p>In any case take a temperature check of the heating plates if there is a discrepancy (see <a href="#">ROUTINE AND SCHEDULED MAINTENANCE</a>).</p> <p>In case of faults of this or any other kind, the manufacturer should be informed. The heating plates (7) and the defective regulators can be repaired or replaced by the manufacturer.</p>
Electrical faults	<p>If a fault develops in the control/regulatory electronic unit, in the first place the automatic switches in the regulating unit should be checked.</p> <p>The automatic switches control output and are accessible from the outside. Supplementary automatic switches to control command current are located inside the regulating unit.</p>



## **E. ORDINARY MAINTENANCE**



## **E.1 General**

### **ATTENTION**

IT IS ESSENTIAL TO CARRY OUT PREVENTIVE MAINTENANCE OF THE HOT-PRESSING DEVICE TO PROTECT THE RELIABILITY OVER TIME OF ITS COMPONENTS AND PARTICULARLY ITS MOVING PARTS.

HARMFUL AGENTS SUCH AS DUST, ENCRUSTATION AND LIQUID SEDIMENTS CAN DAMAGE THE DEVICE'S COMPONENTS.



## **E.2 General warnings**

The operator and/or the maintenance person has the following responsibilities:

To create on and around the hot-pressing device the conditions so that the installed protective guards and devices are operationally effective, as they are there for the purpose of protecting personnel.  
To observe the safety regulations described in the use and maintenance manual.

### **IMPORTANT**

THE INFORMATION DEVICES (SIGNS) AND SAFETY NOTICES MUST BE KEPT CLEAN AND LEGIBLE.

### **ATTENTION**

DO NOT IN ANY WAY ALTER THE SAFETY SYSTEM.

IT IS ABSOLUTELY FORBIDDEN TO REMOVE THE PROTECTIVE DEVICES INSTALLED.

CARRYING OUT CLEANING AND MAINTENANCE JOBS WHILE THE SYSTEMS ARE LIVE OR UNDER PRESSURE IS ABSOLUTELY FORBIDDEN.

DO NOT REMOVE THE GUARDS WHICH REQUIRE TOOLS FOR THEIR REMOVAL.

DO NOT WEAR CLOTHES WITH WIDE SLEEVES.



## **E.3 Routine and scheduled maintenance**

### **IMPORTANT**

Maintenance personnel must have a knowledge of at least the following points:

- How the hot-pressing device is protected.
- Mechanical and electrical safety devices.
- Precautions to observe during maintenance, including how to work under safe conditions.
- Equipment and clothes to be worn to reduce the risks of accidents.
- Maintenance personnel must be authorized and must not wear watches and finger-rings.

### **E.3.1 Preliminary operations**

#### **ATTENTION**

MAKE SURE THAT THE ELECTRICAL EQUIPMENT AND THE SYSTEM ARE NOT LIVE.  
CHECK IF OTHER SOURCES OF ENERGY ARE DISABLED TOO; I.E., AIR FEEDING.

#### **ATTENTION**

BEFORE CARRYING OUT ANY KIND OF WORK ON THE HOT-PRESSING DEVICE IT IS ESSENTIAL TO ENSURE THAT THE SYSTEMS (ELECTRICAL, PNEUMATIC AND WATER) ARE DISCONNECTED FROM ENERGY SUPPLIES, THAT PNEUMATIC AND WATER PL IS PROPERLY DEPRESSURISED AND THAT THERE IS NO REMAINING POTENTIAL ENERGY IN THE MOVING PARTS.



**TABLE 17 - PERIODIC MAINTENANCE WORK**

Operation	Period	Personnel	Method
General cleaning	Daily	Operator	Clean the press after use. Remove dust and any deposits with a clean cloth without the use of solvents.
Check water connections	Daily	Maintenance worker	Check with your fingers that there are no water leaks. If the situation is overlooked for some time there may be calcium deposits visible.
Checking compressed air connections	Monthly	Maintenance worker	Listen for any air leaks.
Check all the electrical cables on the system in its stationary operation	Monthly	Maintenance worker	Check for defective insulation or connectors.
Check all the electrical cables on the system in its mobile operation	Weekly	Maintenance worker	Check defective insulation or connectors.
Measurement of heating plates temperature	Monthly	Maintenance worker	<p>Position the heat-resistant expanded silicone rubber pad on the lower heating plate. Close the press normally. Submit the pressure chamber to a pressure of maximum 1 bar. Switch the heating on, set the nominal value at 180°C and switch the time relay off.</p> <p>After 40 minutes heating time, open the press, slightly lift the upper heating plate and insert a precision thermometer between the expanded silicone rubber pad and the upper heating plate, exactly in the center of the heating plate.</p> <p>Close the hot press (just under its own weight). Take a temperature reading after about 3 minutes.</p> <p>Repeat the procedure for the lower heating plate (insert the sensor under the expanded silicone rubber pad in the center of the heating plate). The temperature measured must be at 180 °C +/- 2 °C (max. measuring precision +/- 1°C ).</p> <p>If the temperature is not yet within the set range it will be necessary to adjust the temperature offset in the PMR-XX unit (see its own manual).</p>



## **F. EXTRAORDINARY MAINTENANCE**



## **F.1 Extraordinary maintenance**

### **F.1.1 Adjustments, replacements and synchronization**

#### **IMPORTANT**

All routine and extraordinary maintenance jobs must be done with the hot-pressing device switched OFF.  
Take special care with replacements and adjustments.  
Maintenance jobs must be done by qualified technicians.

FOR ANY MAINTENANCE WORK THAT DOES NOT COME WITHIN THE CATEGORY OF ORDINARY MAINTENANCE WORK, CONTACT THE TECHNICAL ASSISTANCE OFFICE OF HABASIT.

**Habasis Italiana S.p.A.**  
**Via A. Meucci 8**  
**Zona Industriale**  
**I - 31029 Vittorio Veneto**  
**Tel.: 0039. (0) 438.9113**  
**Fax: 0039. (0) 438.200545**

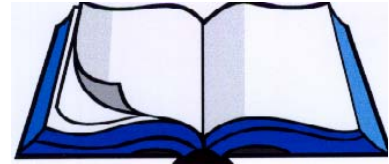



**G. ELECTRICAL, WATER AND COMPRESSED AIR SYSTEM**



G.1 Electrical, water and compressed air system

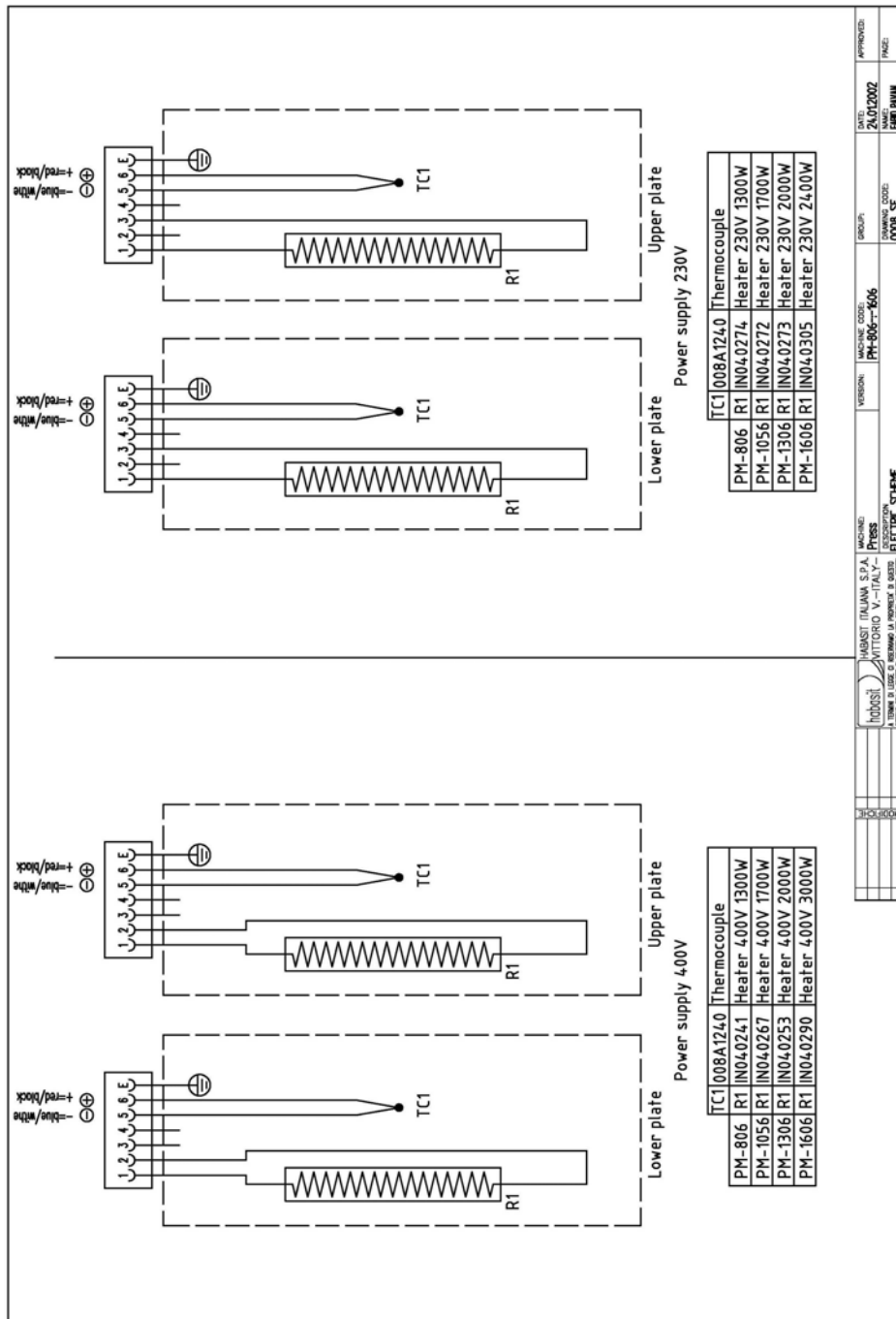

FIGURE 9 - PRESS WIRING LAY-OUT

Habasis Italiana S.p.A.  
Vittorio Veneto 31029 (TV)  
Tel.: ++39(0)438.9113  
Fax. ++39(0)438.200545



## Hot Press PM-2006



---

Author: S.D.T. / KM  
Edition: 02/2005  
Replaces: 01/2002

**GLOSSARY**  
Page H-1

---

## H. GLOSSARY

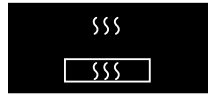

## H.1 Glossary of terms

**TABLE 18 - GLOSSARY**

Terms	Description
PMR-XX	Equipment for the regulation and control of the temperature rise of the hot-pressing device while managing the device's electrical circuitry. The suffix XX means that a range of different units may be used (PMR-04, PMR-305 etc.) as long as they are compatible with the type of press used (see <a href="#">B.4.3 Regulating unit options</a> ).
PMC-XX	Control unit to cool the hot-pressing device and maintain the compressed air circuit management. The suffix XX means that various units can be used (PMC-04, PMC) provided they are compatible with the type of regulating unit used (see <a href="#">B.4.4 Cooling unit options</a> ).
Thermofix	Belt joining process (see technical manual Thermofix)
Flexproof	Belt joining process (see technical manual Flexproof)
Heating box	The unit containing the heating plates and pressure cushion, designed to contain the heat and protect the operator
Lower heat equalizing plate	Refers to lower belt support
Upper heat equalizing plate	Refers to upper belt support
Clamping bar	A bar that exerts pressure on the belt being worked on, to keep it in place.
Cushion (or AIRBAG)	Expandable airbag that exerts pressure on the belt/tape
Molleton	Special fabric used as pressure equalization under the belt/tape

Habasis Italiana S.p.A.  
Vittorio Veneto 31029 (TV)  
Tel.: ++39(0)438.9113  
Fax. ++39(0)438.200545



**Hot Press PM-2006**



---

Author: S.D.T. / KM  
Edition: 02/2005  
Replaces: 01/2002

**SPARE PARTS**  
Page I-1

---

## **I. SPARE PARTS**





**TABLE 19 - SPARE PARTS AND INTERNAL PARTS**

Pos.	Code	Description	M.U.	Q.ty
1	ID000965	EXTERNAL PROFILE	N°	2
2	ID000966	INTERNAL PROFILE	N°	2
3	008A1030	HOOK	N°	20
4	008A1040	PROTECTION DEVICE	N°	4
5	008A1050	SPACER De10 Di8 L45	N°	20
6	008A1060	SECTION FASTENING WITH SLOTTED HOLE	N°	16
7	008A1070	SECTION FASTENING WITH ROUND HOLE	N°	4
8	008A1080	SPRING PLATE	N°	16
9	008A1090	SPRING De14,5 d1,8 Lo41	N°	16
10	008A1346	COOLING CONNECTOR	N°	2
11	ID000967	CONCAVE SPACER	N°	2
12	ID000968	SPACER SP.15	N°	2
13	ID000969	INSULATOR	N°	2
14	008A1240	THERMOCOUPLE	N°	2
15	IN011310	HH SCREW DIN 7984-M6x16 lowered head STAINLESS STEEL A2	N°	56
16	IN011440	HH SCREW UNI-ISO 7380-M5x8 STAINLESS STEEL	N°	8
17	IN011441	HH SCREW UNI 5931-M6x18 STAINLESS STEEL	N°	40
18	205C1170	FEED AND DISCHARGE TUBE	N°	4
19	IN020416	COUPLING 162A 1/4" FEMALE	N°	4
20	IN010848	HH SCREW UNI 5931-M4x10 STAINLESS STEEL	N°	4
21	IN010202	WASHER UNI 6592-4.3x9 STAINLESS STEEL	N°	4
22	IN011442	HH SCREW UNI 9327-M8x55 lowered head GALVANIZED	N°	20
23	IN010423	RECESSED CONICAL PLUGS SHORT TYPE 1/8 gas DIN 906 BRAS	N°	2
24	IN021037	Union M1/8 – M1/8 code 2060	N°	4
25	IN010146	COPPER WASHER 1/4"	N°	8
26	IN011443	Screw for hardboard panels with cross slotting d4x20	N°	48





**TABLE 20 - SPARE PARTS AND PRESSER CUSHION L=2000**

Pos.	Code	Description	M.U.	Q.ty
1	IN060326	FLATTENING TUBE Øi 51 cod.1640909 IVG COLBACCHINI	ML	2,13
2	IN020946	HOSE END-ACCESSORY code 2601-7-1/8 CAMOZZI	N°	1
3	008B1010	REAR CUSHION RESTRAINING PLATE	N°	1
4	008B1020	REAR CUSHION RESTRAINING PLATE	N°	1
5	008B1030	FRONT CUSHION RESTRAINING PLATE	N°	1
6	008B1040	FRONT CUSHION RESTRAINING PLATE	N°	1
7	008B1050	COMPENSATION PLATE	N°	1
8	IN010114	CHH SCREW UNI 5931-M5x16 GALVANIZED	N°	7
9	IN020952	L-UNION with washer code 1493 - 6/4 - 1/8	N°	1



Author: S.D.T. / KM  
 Edition: 02/2005  
 Replaces: 01/2002

**SPARE PARTS**  
 Page I-6

**I.3 External spare parts**

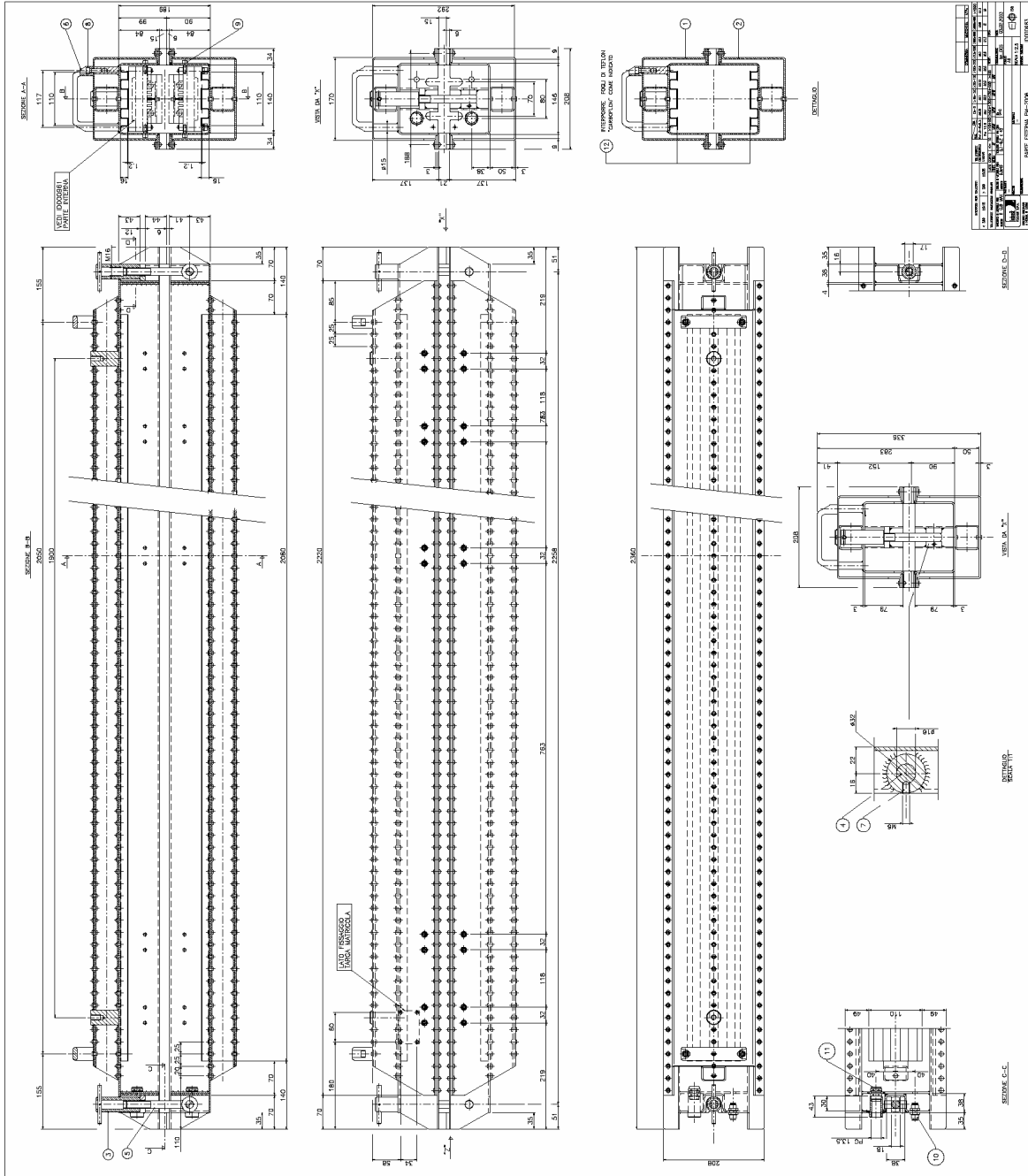

**FIGURE 12 - EXTERNAL SPARE PARTS**



**TABLE 21 - EXTERNAL SPARE PARTS**

Pos.	Code	Description	M.U.	Q.ty
1	ID000970	UPPER BEAM	N°	1
2	ID000971	LOWER BEAM	N°	1
3	008C1040	KNOB	N°	2
4	008C1050	PIN	N°	2
5	IN011444	GN.12546 DIN444-M16-130 ELESA EYEBOLT	N°	2
6	IN060003	M. 443/140 N 37131 HANDLE	N°	2
7	IN011445	TIP PIN UNI ISO 5927 M6X10	N°	2
8	IN011157	CHH SCREW UNI 5931-M8x55 GALVANIZED	N°	4
9	IN010020	CHH SCREW UNI 5931-M6x20 GALVANIZED	N°	40
10	IN020951	QCK-1/8-PK-4-B through connector code 9425	N°	2
11	IN040201	CABLE CLAMP art. 1300.13.06.35	N°	2



Author: S.D.T. / KM  
 Edition: 02/2005  
 Replaces: 01/2002

**SPARE PARTS**  
 Page I-8

**I.4 Spare parts of belt clamping system**

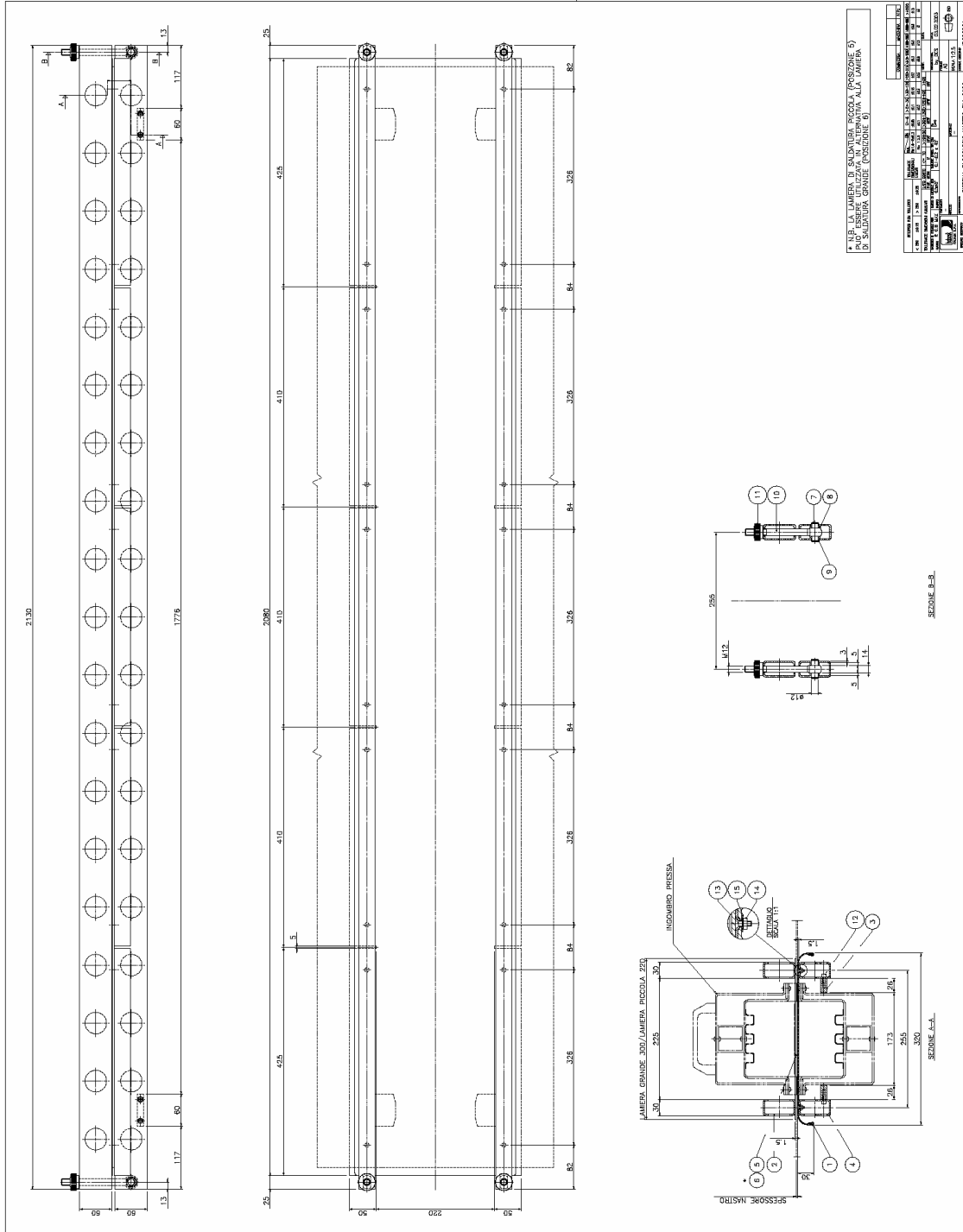

**FIGURE 13 - BELT LOCKING SYSTEM SPARE PARTS**

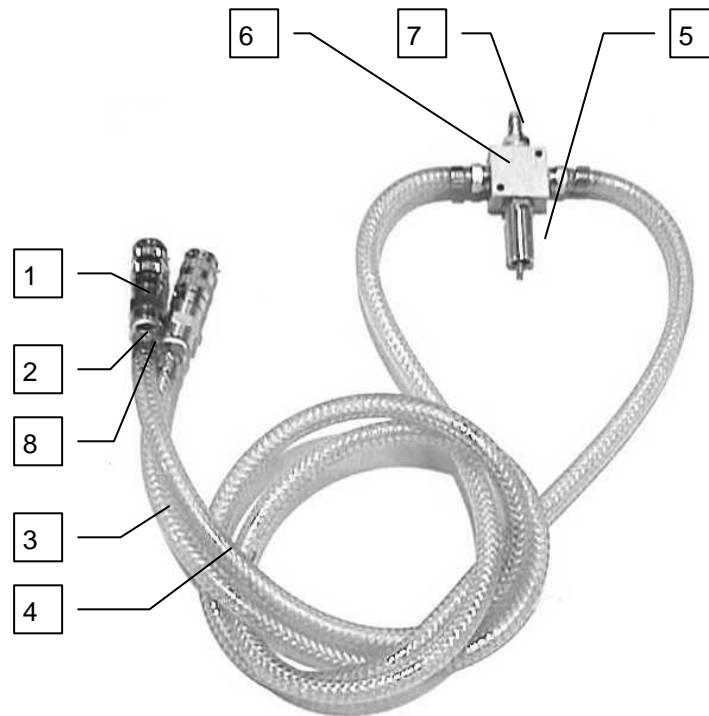

**TABLE 22 - BELT LOCKING SYSTEM SPARE PARTS**

Pos.	Code	Description	M.U.	Q.ty
1	ID000972	BOTTOM HEAT EQUALIZING PLATE PM-2006	N°	1
2	ID000973	UPPER PRESSER	N°	2
3	ID000594	SPACER	N°	4
4	ID000974	LOWER PRESSER	N°	2
5	ID000975	SMALL HEAT EQUALIZING PLATE – 220 mm	N°	1
6	ID000976	LARGE HEAT EQUALIZING PLATE – 300 mm	N°	1
7	205D1050	PRESSER CLOSURE SCREW PIN	N°	4
8	205D1060	EYEBOLT SPACER	N°	8
9	IN010149	EXTERNAL SEEGER e12 UNI 7435	N°	8
10	IN010144	DIN 444 - M12x130 EYEBOLT code GN.12536	N°	4
11	IN010496	B. 193/30 FP-M12 KNURLED KNOB cod. 2514	N°	4
12	IN010108	CHH SCREW UNI 5931 - M5x12 GALVANIZED	N°	8
13	IN010582	OHH SCREW UNI 5933 - M4x12 GALVANIZED	N°	12
14	IN010148	UNI 5588-68 - M4 GALVANIZED NUT	N°	12
15	IN010172	UNI 6592 - 4.3x9 GALVANIZED WASHER	N°	12



**I.5 Spare parts for pneumatic connection**



**FIGURE 14 - SPARE PARTS FOR PNEUMATIC CONNECTION**

**TABLE 23 - SPARE PARTS FOR PNEUMATIC CONNECTION**

Pos.	Code	Description	M.u.	Q.ty
	008E1000	AIR CONNECTION	NR	1
1	IN020655	FEMALE COUPLING 04 MINI ¼" code 01010004	NR	2
2	IN020407	HOSE-END FITTING 6x¼" code 1.13234	NR	4
3	IN020410	PLASTIC TUBE PVC 6x12 code TA06	NR	1
4	IN020410	PLASTIC TUBE PVC 6x12 code TA06	NR	1
5	IN020406	SAFETY VALVE F. ¼" calibrated at 3 bars and punched code. 1.441	NR	1
6	IN020950	X DIVIDER F.F.F.F. ¼" cod. 150.4	NR	1
7	IN020656	CORE COUPLING 12 mini ¼" code 0102012	NR	1
8	IN020412	COLLAR WITH TWO EARS COL-PI 11x13	NR	4

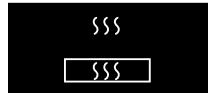

## I.6 Spare parts for electrical, water and compressed air connections

**TABLE 24 - SPARE PARTS FOR ELECTRICAL, WATER AND AIR CONNECTIONS USED IN STATIONARY OPERATION**

Pos.	Description	M.U.	Q.ty	Assembly code	Parts code
	CABLE CONNECTION PAIR REGULATOR PMR-04/PMR-06 AND OUTLET PM-PRESS	N°	1	691011	
	PNEUMATIC CONNECTION	N°	1	20501000	
	PLASTIC TUBE PVC 6x12 code TA06	ML	5 m		IN020410
	TUBE CLAMP 14x24 MINUSSGM	N°	12		IN020411
	COLLAR WITH TWO EARS COL-PI 11x13	N°	3		IN020412
	FEMALE COUPLING ¼" code 403 1/4SV (RAPID FIT)	N°	4		IN020413
	HOSE-END ACCESSORY 12x¼" CH 17	N°	4		IN020371
	HOSE-END ACCESSORY 6x¼" code 1.13234	N°	1		IN020407
	MANITOBA TUBE D.10x21mm 170° L=20ml	N°	1		IN020429
	COPPER WASHER ¼"	N°	4		IN010146
	FEMALE COUPLING 04 MINI ¼" code 01010004	N°	1		IN020655



Author: S.D.T. / KM  
 Edition: 02/2005  
 Replaces: 01/2002

**TABLE 25 - SPARE PARTS FOR ELECTRICAL, WATER AND AIR CONNECTIONS USED IN MOBILE OPERATION**

Pos.	Description	M.U.	Q.ty	Assembly code	Parts code
	CABLE CONNECTION PAIR REGULATOR PMR-04/PMR-06 AND OUTLET PM	N°	1	691011	
	MOBILE COOLING PUMP. The cooling pump may depend on the electrical tension available.	N°	1		
	MOBILE COOLING PUMP PM-04/7 230V	N°		691016	
	MOBILE COOLING PUMP PM-04/6 120V	N°		691015	
	IMMERSION PUMP 220V	N°	1		709000
	IMMERSION PUMP 120V	N°	1		709002
The following parts are in common irrespective of the tension applied to the pump					
	50 LITER BIN	N°	1		709003
	COOLING WATER DISCHARGE TUBE PM-04/6/7	N°	1		700021
	TUBE COLLAR - DIAM 100mm M10	N°	1		700500
	FEMALE CONNECTION ¼" code 403 1/4SV	N°	4		IN020413
	RUBBER HOSE FOR AIR/WATER 20 bar 25 x 37	MT	0.16		702508
	RUBBER HOSE FOR AIR/WATER 20 bar 16 x 26	MT	10		702509
	RUBBER HOSE FOR AIR/WATER 20 bar 13 x 23	MT	10		702511
	PMR-06 OUTPUT ADAPTOR	N°	1		IN040301
	MOBILE MINI COMPRESSOR The compressor may vary according to the electrical tension available	N°	1		
	MOBILE MINI COMPRESSOR MC-04/7 230V	N°		691017	
	MOBILE MINI COMPRESSOR MC-04/6 120V	N°		691018	
	MINI COMPRESSOR 220V	N°	1		709001
	MINI COMPRESSOR 120V	N°	1		709004
The following parts are in common irrespective of the tension applied to the compressor					
	RADIAL MANOMETER ¼" GLICER 1-6 bar	N°	1		700516
	FAUCET SERIES A/4» F-F	N°	1		700517
	FEMALE CONNECTION 04 MINI ¼" code 0101004	N°	1		IN020655
	COLLAR WITH TWO EARS COL-PI 11x13	N°	1		IN020412
	PLASTIC TUBE PVC 6x12 code TA06	N°	5		IN020410
	PMR-06 OUTPUT ADAPTOR	N°	1		IN040301
	CONNECTION ADAPTOR DIRECT TO PMR-06 (only for 230V)-	N°	1		N-26964

Habasis Italiana S.p.A.  
Vittorio Veneto 31029 (TV)  
Tel.: ++39(0)438.9113  
Fax. ++39(0)438.200545



**Hot Press PM-2006**



---

Author: S.D.T. / KM  
Edition: 02/2005  
Replaces: 01/2002

**ANNEXED COMMERCIAL DOCUMENTS**

Page J-1

---

**J. ANNEXED COMMERCIAL DOCUMENTS**



## **J.1 Water circulation pump**





Author: S.D.T. / KM  
Edition: 02/2005  
Replaces: 01/2002

**ANNEXED COMMERCIAL DOCUMENTS**

Page J-3

## J.2 Portable compressor





---

### Product liability, application considerations

If the proper selection and application of Habasis products are not recommended by an authorized Habasis sales specialist, the selection and application of Habasis products, including the related area of product safety, are the responsibility of the customer.

All indications / information are recommendations and believed to be reliable, but no representations, guarantees, or warranties of any kind are made as to their accuracy or suitability for particular applications. The data provided herein are based on laboratory work with small-scale test equipment, running at standard conditions, and do not necessarily match product performance in industrial use. New knowledge and experiences can lead to modifications and changes within a short time without prior notice.

BECAUSE CONDITIONS OF USE ARE OUTSIDE OF HABASIT'S AND ITS AFFILIATED COMPANIES CONTROL, WE CANNOT ASSUME ANY LIABILITY CONCERNING THE SUITABILITY AND PROCESS ABILITY OF THE PRODUCTS MENTIONED HEREIN. THIS ALSO APPLIES TO PROCESS RESULTS / OUTPUT / MANUFACTURING GOODS AS WELL AS TO POSSIBLE DEFECTS, DAMAGES, CONSEQUENTIAL DAMAGES, AND FURTHER-REACHING CONSEQUENCES.

---