

Description

Metric, AT shape, Modified trapezoidal, 5 mm pitch, (Standard) steel cord

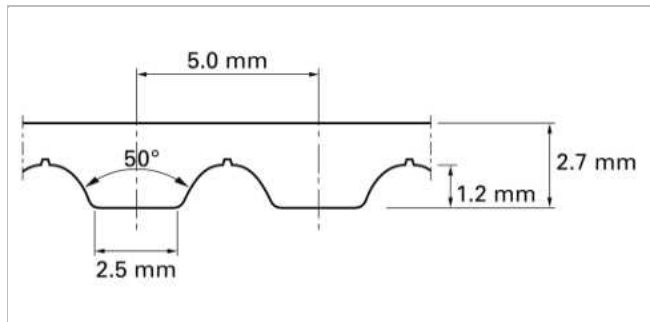
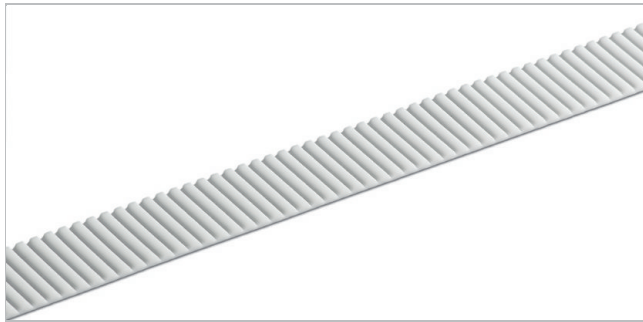

Sketch of basic shape

Product Construction / Design								
Material Type	Color	Hardness	Temperature range				Food grade ¹	Characteristic
			°C	°F	°C	°F		
01	White	92	-20	-4	80	176	No	TPU - polyester
05	Cobalt blue	90	-30	-22	80	176	Yes	TPU - polyether
16	Transparent	85	-30	-22	80	176	Yes	TPU - polyester
22	Transparent	90	-20	-4	70	158	Yes	TPU - polyester
06	Black	92	-20	-4	80	176	No	TPU - polyester

⁽¹⁾ This product is in compliance with relevant EU and/or US food contact requirements. Check the following link for detailed information [Documents of Compliance](#)

Standard belt options - Conveying side

Unprocessed (U)

Standard belt options - Teeth side

Unprocessed (U), Green polyamide fabric (P), Antistatic black polyamide fabric (A)⁽²⁾

⁽²⁾ Fulfills ISO 9563

Technical data									
Belt slitting width, nominal		Admissible tensile force, truly endless belt		Ultimate tensile strength		Tensile force for 1% elongation		Mass of belt (belt weight)	
mm	inch	N	lbf	N	lbf	N	lbf	kg/m	lb/ft
50.0	2.0	2970	668	12540	2819	7410	1666	0.18	0.12

Maximum belt width (150 mm / 6 inch).

Belt versions with increased thickness are available on request. Please consider larger minimum pulley diameters.

The admissible tensile force always corresponds with a belt elongation of 0.4%. Joined belts are calculated with half admissible force. Please contact Habasit for detailed information and calculations.

[Link to JDS:](#)

Unit load table

RPM	F _i	M _i	P _i	RPM	F _i	M _i	P _i	RPM	F _i	M _i	P _i
[min ⁻¹]	[N/cm]	[Nm/cm]	[W/cm]	[min ⁻¹]	[N/cm]	[Nm/cm]	[W/cm]	[min ⁻¹]	[N/cm]	[Nm/cm]	[W/cm]
0	35.61	0.028	0.000	1000	25.92	0.021	2.159	2800	19.96	0.016	4.657
20	35.17	0.028	0.059	1100	25.41	0.020	2.329	3000	19.53	0.015	4.879
40	34.74	0.028	0.116	1200	24.98	0.020	2.498	3200	19.12	0.015	5.099
60	34.33	0.027	0.172	1300	24.50	0.020	2.659	3400	18.74	0.015	5.308
80	34.01	0.027	0.227	1400	24.08	0.019	2.811	3600	18.38	0.015	5.510
100	33.69	0.027	0.281	1500	23.68	0.019	2.962	3800	18.02	0.014	5.709
200	32.25	0.026	0.538	1600	23.35	0.019	3.112	4000	17.70	0.014	5.899
300	31.19	0.025	0.779	1700	22.97	0.018	3.253	4500	16.94	0.013	6.350
400	30.11	0.024	1.005	1800	22.65	0.018	3.394	5000	16.25	0.013	6.769
500	29.27	0.023	1.219	1900	22.34	0.018	3.534	5500	15.62	0.012	7.160
600	28.46	0.023	1.422	2000	22.04	0.017	3.673	6000	15.06	0.012	7.527
700	27.74	0.022	1.618	2200	21.44	0.017	3.930	6500	14.53	0.011	7.866
800	27.05	0.022	1.805	2400	20.93	0.016	4.185				
900	26.51	0.021	1.986	2600	20.42	0.016	4.426				

Technical data					
ØB		n _B	ØA		n _A
mm	inch		mm	inch	
25	0.98	15	60	2.36	25



All data are approximate values under **standard climatic conditions**: 23 °C / 73 °F, 50% relative humidity (DIN 50005 / ISO 554), and are based on the Master Joining Method.

Limited representative testing based on a standard configuration is carried out to estimate minimum pulley diameters. Please contact Habasit for specific guidance regarding non-standard applications, including, but not exclusively, when profiles or cleats are used, or if the belt working temperature is close to the limits listed in this document.

Disclaimer

Product Application Disclaimer (valid for ALL Habasit products and mentioned on all PDS)

This disclaimer is made by and on behalf of Habasit and its affiliated companies, directors, employees, agents and contractors (hereinafter collectively "HABASIT") with respect to the products referred to herein (the "Products"). SAFETY WARNINGS SHOULD BE READ CAREFULLY AND ANY RECOMMENDED SAFETY PRECAUTIONS BE FOLLOWED STRICTLY! Please refer to the Safety Warnings herein, in the Habasit catalogue as well as installation and operating manuals. All indications / information as to the application, use and performance of the Products are recommendations provided with due diligence and care, but no representations or warranties of any kind are made as to their completeness, accuracy or suitability for a particular purpose. The data provided herein are based on laboratory application with small-scale test equipment, running at standard conditions, and do not necessarily match product performance in industrial use. New knowledge and experience may lead to re-assessments and modifications within a short period of time and without prior notice. EXCEPT AS EXPLICITLY WARRANTED BY HABASIT, WHICH WARRANTIES ARE EXCLUSIVE AND IN LIEU OF ALL OTHER WARRANTIES, EXPRESS OR IMPLIED, THE PRODUCTS ARE PROVIDED "AS IS". HABASIT DISCLAIMS ALL OTHER WARRANTIES, EITHER EXPRESS OR IMPLIED, INCLUDING, BUT NOT LIMITED TO, IMPLIED WARRANTIES OF MERCHANTABILITY, FITNESS FOR A PARTICULAR PURPOSE, NON-INFRINGEMENT, OR ARISING FROM A COURSE OF DEALING, USAGE, OR TRADE PRACTICE, ALL OF WHICH ARE HEREBY EXCLUDED TO THE EXTENT ALLOWED BY APPLICABLE LAW. BECAUSE CONDITIONS OF USE IN INDUSTRIAL APPLICATION ARE OUTSIDE OF HABASIT'S CONTROL, HABASIT DOES NOT ASSUME ANY LIABILITY CONCERNING THE SUITABILITY AND PROCESS ABILITY OF THE PRODUCTS, INCLUDING INDICATIONS ON PROCESS RESULTS AND OUTPUT.